



Humor 20 + Automatic Calibration Module

HUMIDITY CALIBRATOR

MANUAL
Hardware + Software

YOUR PARTNER IN SENSOR TECHNOLOGY



ELEKTRONIK®
Ges.m.b.H.

Table of contents

1.	FOREWORD	3
2.	SCOPE OF SUPPLY	4
	2.1 <i>Humor 20</i>	4
	2.2 <i>Automatic calibration module (optional)</i>	4
3.	SAFETY INSTRUCTIONS	5
	3.1 <i>General</i>	5
	3.2 <i>Humor20</i>	5
4.	OPERATING PRINCIPLE	6
5.	OPERATING COMPONENTS	7
	5.1 <i>Humor 20</i>	7
	5.2 <i>Automatic calibration module (optional)</i>	7
6.	GENERAL USER INSTRUCTIONS	7
	6.1 <i>Setup</i>	7
	6.2 <i>Starting up Humor 20</i>	8
	6.3 <i>Starting up Humor 20 with automatic calibration module</i>	9
	6.4 <i>Verifying the 100 % RH Point</i>	11
7.	CALIBRATION AND ADJUSTMENT PROCEDURE	12
	7.1 <i>Cubical transmitters (room design) with Humor 20</i>	12
	7.2 <i>Transmitter with sensor probe with Humor 20</i>	12
	7.3 <i>Transmitter EE33 Model J with Humor 20</i>	13
	7.4 <i>Analogue Output Humor 20</i>	14
	7.5 <i>Calibration with the automatic calibration module</i>	14
	7.6 <i>Power failure during the calibration procedure</i>	14
	7.7 <i>Ending the calibration or adjustment procedure</i>	14
8.	HUMOR 20 SOFTWARE	15
	8.1 <i>Installation the software</i>	15
	8.2 <i>Configuration mode control panel</i>	16
	8.3 <i>Menu bar</i>	16
	8.3.1 <i>Operation</i>	16
	8.3.2 <i>Adjustment / Calibration</i>	22
	8.3.3 <i>Pressure Compensation</i>	23
	8.4 <i>Measurements</i>	24
	8.4.1 <i>Start screen</i>	24
	8.4.2 <i>"Test unit" configuration field</i>	24
	8.4.3 <i>"Measurements" configuration field</i>	26
	8.5 <i>Fixed RH Value (only available when using an automatic calibration module)</i>	27
9.	MAINTENANCE	27
	9.1 <i>Re-fill water (at error message - waterlevel low)</i>	27
	9.2 <i>Drain water (at error message - waterlevel high or long idle periods)</i>	27
	9.3 <i>Cleaning</i>	27
10.	WARNINGS / ERROR MESSAGES ON THE DISPLAY	28
	10.1 <i>Humidity - display flashes</i>	28
	10.2 <i>Warning: OUT OF SPEC</i>	28
	10.3 <i>Warning: WATERLEVEL HIGH</i>	28
	10.4 <i>Warning: WATERLEVEL LOW</i>	29
	10.5 <i>Error message: heat defect</i>	29
	10.6 <i>Error message: pressure excess</i>	29
	10.7 <i>Humidity - display is incorrect</i>	29
	10.8 <i>Stabilisation time too long</i>	29
	10.9 <i>Leakage in filter set</i>	30
	10.10 <i>Electronic defect - replace electronics</i>	30
	10.11 <i>Fuse defect - Replacing the fuse (Humor 20 + Autokit)</i>	30
11.	TECHNICAL DATA	31
12.	ACCESSORIES	32
	12.1 <i>Oil-free compressor</i>	32
	12.2 <i>Covers for measuring chamber</i>	32
	12.3 <i>Calibration certificate</i>	32
	12.4 <i>Automatic calibration module</i>	32

LIMITED LIABILITY

E+E Elektronik® shall not be held liable for any damage or consequential damage (for example, but not restricted to, loss of earnings, interruption of business, loss of information and data or any other financial losses) resulting from the setup, use or impossibility of use of an E+E Elektronik® software product and any associated support services or non-performance of support services.

E+E Elektronik® Ges.m.b.H. is not responsible for the completeness of this publication and shall not be liable for the products described herein in the event of improper handling.

This publication may contain technical inaccuracies or typographical errors. The information contained herein is revised regularly. These changes will be implemented in later editions. The products described herein may be improved or changed at any time.

© Copyright E+E Elektronik GmbH // All rights reserved // Subject to change without notice

1. FOREWORD

E+E Elektronik® Ges.m.b.H. developed this device to accurately generate the relative humidity (U_w).

As such, this professional tool represents the manufacturer's current status of knowledge with regard to development, design and production. The manufacturer is confident that the humidity calibrator Humor 20 meets all the requirements and expectations that you, the buyer, demand of a new acquisition. If the device is handled properly and serviced regularly it should work reliably for several years.

This manual forms part of the scope of supply and serves to ensure proper handling and optimal performance of the device.

Therefore, make sure you read the manual before you take the device into operation. The manual is also to be brought to the attention of any person involved in transport, setup, operation, maintenance or repair.

This manual must not be used for competitive purposes without our written consent and must not be passed on to third parties. Copies for personal use are permitted.

All information, technical data and illustrations contained in this manual are based on the information available at the time of publication.

E+E Elektronik® Ges.m.b.H. reserves the right to change the technical data or make other technical modifications at any time and without prior notice without being committed to retrofitting models produced before such a change was made.

General

This manual is part of the scope of supply and serves to ensure the optimum operation and performance of the device.

To ensure correct operation, this manual must be read before the device is taken into operation.

Explanation of symbols



This symbol indicates a safety instruction.

These safety instructions must always be followed. The manufacturer is not liable for any damage resulting from non-compliance. In this case, the user is solely responsible for his actions.



This symbol indicates a note.

These notes should be observed to achieve optimal performance of the equipment.

2. SCOPE OF SUPPLY

2.1 Humor 20

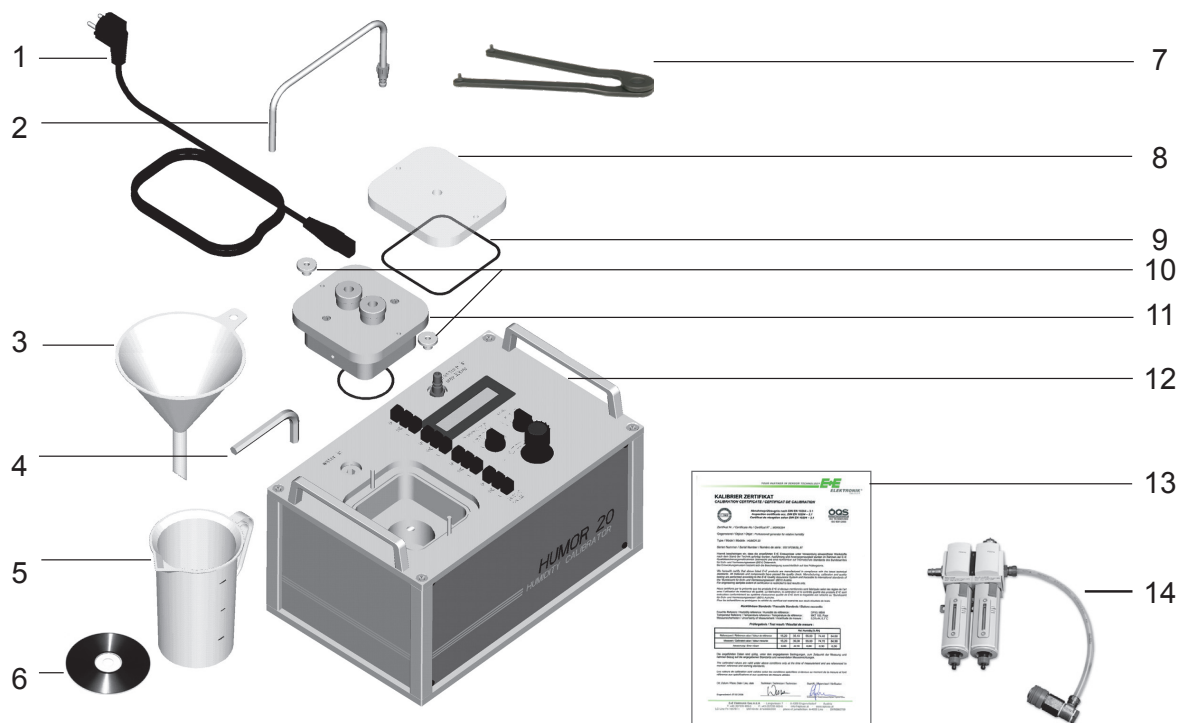

- | | |
|---|--|
| 1 Power supply cable IEC Europe (230V) + power supply cable IEC Northamerica (110V) | 9 O-ring for room transmitter |
| 2 Water drain pipe with connector | 10 Knurled nut |
| 3 Funnel | 11 Cover for measuring chamber (ordering code HA0202xx) (not included in the scope of supply Humor 20) |
| 4 Allen key (10mm / 0.4") | 12 Fixing bracket for filter set (pre-mounted) |
| 5 Measuring beaker | 13 Works certificate acc. DIN EN 10204-3.1 |
| 6 Measuring and calibration software | 14 Filter set with oil separator |
| 7 Face pin wrench | |
| 8 Plexiglas cover for room transmitter testing | |

2.2 Automatic calibration module (optional)

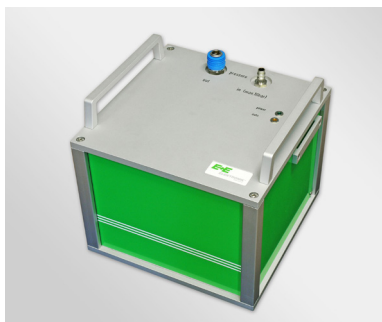

- Automatic calibration module
- Power supply cable IEC Europe (230 V)
- Power supply cable IEC North America (110 V)
- RS232 connection cable to Humor 20
- Compressed-air connecting hose to Humor 20

3. SAFETY INSTRUCTIONS

3.1 General

Humor 20 is designed based on state-of-the-art technology, which means it will operate reliably if it is kept in good condition and operated and serviced correctly. This device may pose a risk if it is operated improperly by untrained personnel.

Improper use can:

- Injure operating personnel and damage the device itself or other assets belonging to the user.
- Prevent the device from working efficiently and accurately.

Observe the following information to ensure operational safety:



- Only qualified or specially trained staff may operate or perform work on the humidity calibrator. Unauthorised changes or modifications are either not permitted or require the express permission of the manufacturer.
- Read this manual carefully before taking the device into operation. The manual must also be made available to any person involved in transport, setup, operation, maintenance or repair (particularly when loaning or selling the device to a third party).
- Only operate the device if it is in good condition. Any fault must be repaired by authorised personnel or by an E+E Elektronik sales partner before it is taken into operation again.

3.2 Humor 20



- Check whether the supply voltage data on the nameplate matches the local supply voltage. This also applies to the automatic calibration module.
- Only power the humidity calibrator via a grounded power outlet (safety precaution). This also applies to the automatic calibration module.
- Humor 20 and automatic calibration module should be placed in a way which allows an as easy as possible disconnection from the power supply.
- Before opening the water intake, make sure that the humidity calibrator is no longer under pressure (controller turned to the left as far as it will go; if Humor 20 already in service, display shows RH > 90%).
- Humor 20 may only be operated with distilled (deionised) water.
- Before connecting the compressed air or nitrogen supply, make sure that the controller is turned to the left as far as it will go.
- The device may only be operated with filtered compressed air with a contamination level of <math><0.01\text{mg}/\text{m}^3</math>.
- The media supply may not exceed an absolute pressure of 10 bar (pressure gauge and safety value recommended for use in the supply line).



- **If a humidity calibrator is filled with water and ready for operation, it must not be tilted by more than 20° during transportation. If this is not possible, Humor 20 must be drained completely, see section "9.2 Drain water".**
- **Once Humor 20 has been switched off, it must also be disconnected from the compressed air (because of possible condensation in the lines as the heating is turned off).**

4. OPERATING PRINCIPLE

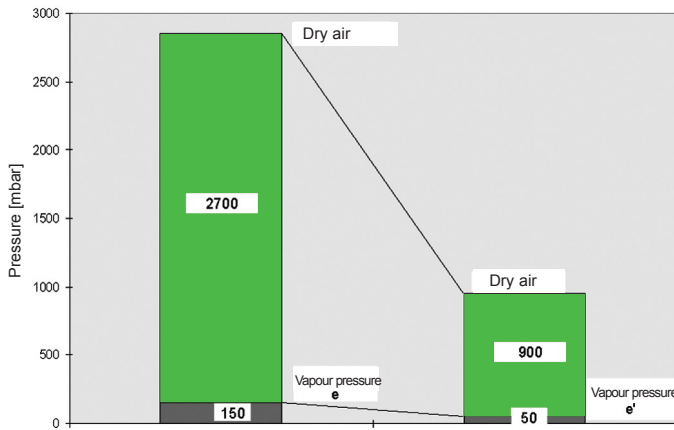

Air or nitrogen under pressure p_1 is fed into chamber 1 and humidified. The developing saturation vapour pressure e_{ws} is a direct result of the temperature of the chamber respectively the water. Next, the humidified air is expanded to pressure p and fed into chamber 2. During expansion, the vapour pressure e_{ws} is reduced in the same ratio as the overall pressure of the air. Therefore, the water vapour pressure in chamber 2 is:

$$e = e_{ws} * p/p_1$$

Thanks to the special design of Humor 20 with its high thermal conductivity, chamber 1 always has the same temperature as chamber 2.

Consequently, if the temperature is the same, the saturation vapour pressure e_{ws} of chamber 1 is identical to that of chamber 2. As a result of the expansion of the humidified air, chamber 2 contains the water vapour partial pressure e .

From the definition for relative humidity follows for chamber 2:

$$rh = e/e_{ws} = e_{ws} * (p/p_1) / e_{ws} = p/p_1$$

Hence, the relative humidity in chamber 2 is a direct result of the ratio of the pressures in chambers 1 and 2.

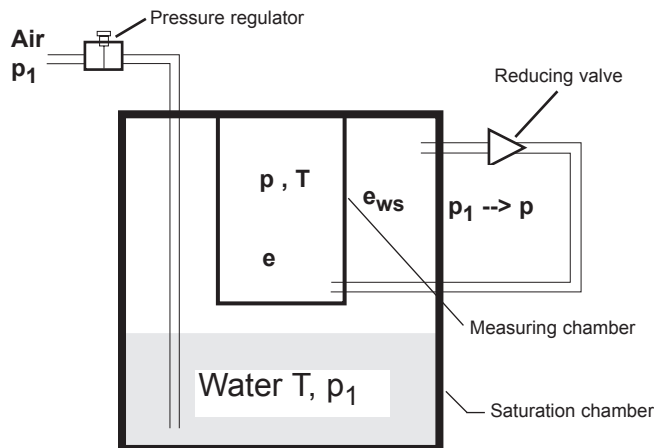

Schematic diagram of a two-pressure reactor

In addition, the relative humidity generated in Humor 20 is practically independent of the ambient temperature and only dependent on the pressures p and p_1 . The only precondition is that the temperature of chambers 1 and 2 and the water in chamber 1 is the same.

The relative humidity in chamber 2 can be varied by adjusting the inlet pressure p_1 . During operation, the pressures in chambers 1 and 2 are measured and the actual relative humidity is calculated with the above equation and shown in the display of the calibrator.

5. OPERATING COMPONENTS

5.1 Humor 20

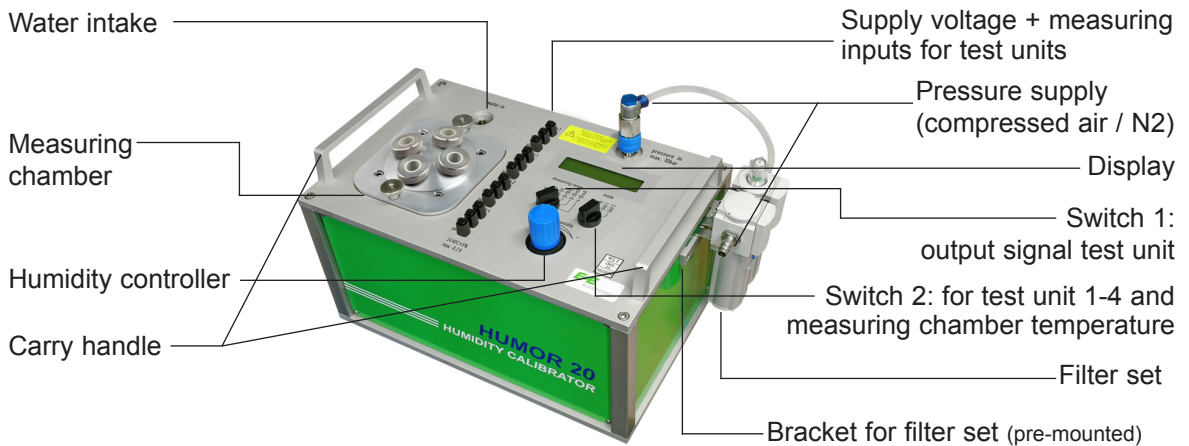

Humor 20 - Back Side



5.2 Automatic calibration module (optional)

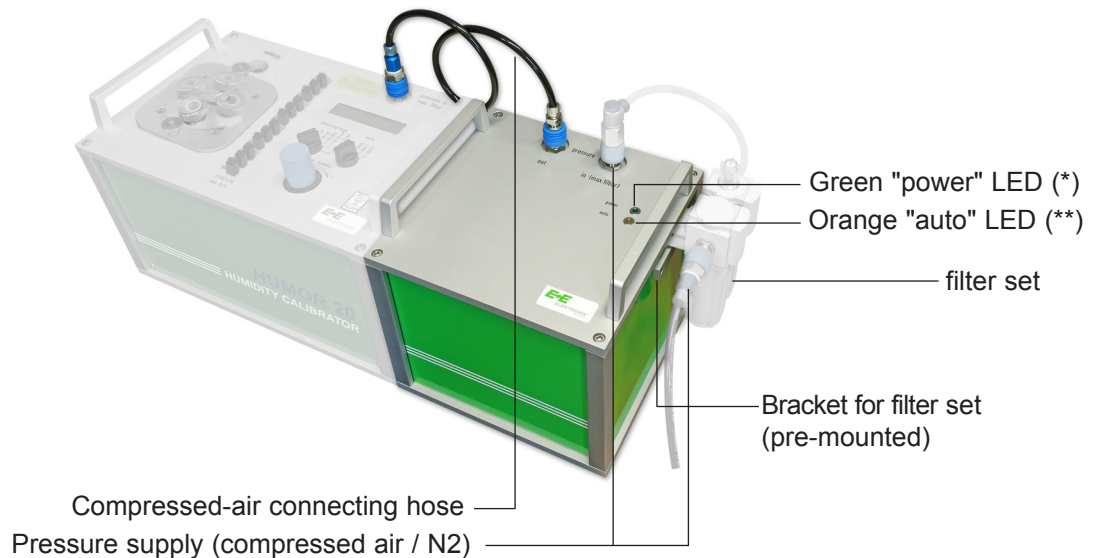

- (*) Lights up when power is supplied
- (**) - Flashes: Adjusted to setpoint
- Lights up: Setpoint reached

6. GENERAL USER INSTRUCTIONS

6.1 Setup

Operating range: 10...40 °C / 10...80 % rH.

Do not perform measurements in direct sunlight or while exposed to other external sources of heat.

Do not operate Humor 20 in potentially-explosive areas or expose it to strong mechanical vibrations. If Humor 20 is transported when it is ready for operation (filled with distilled water), do not tilt the housing by more than 20°.



6.2 Starting up Humor 20



Humor 20 must acclimatise at least 6 hours on-site at the calibration location.

Apply voltage supply.
Plug the power supply cable into the device and a grounded power outlet.

Activate the main switch.



Turn the humidity controller to the left (anti-clockwise) as far as it will go.



Open the water tank. Ignore the warm-up time.
Use the Allen key supplied to open the screw plug.



Before opening the water tank, make sure that the humidity calibrator is no longer under pressure. Turn the humidity controller to the left (anti-clockwise) as far as it will go and wait until "RH > 90 %" is shown in the display of Humor 20.

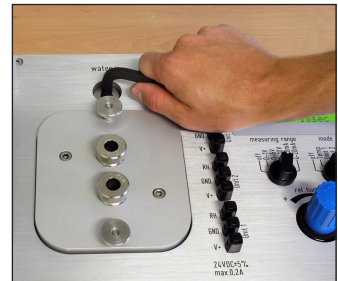

Fill Humor 20 with distilled water.
Fill the humidity calibrator with max. 1000 ml distilled (deionised) water.
If the maximum level is exceeded, the warning WATERLEVEL HIGH is shown in the display. If this happens, drain water until the warning disappears (see section "9.2 Drain water").



During the filling process, make sure that no water enters the measuring chamber.



Close the water tank.
Use the Allen key supplied to tighten the screw plug.



Wait until the warm-up phase is completed.
The warm-up phase will take 20 minutes (display: WARM UP TIME).



Attach the oil separator / filter set to the side of Humor 20, on the bracket, and establish a connection to the input "Pressure in".

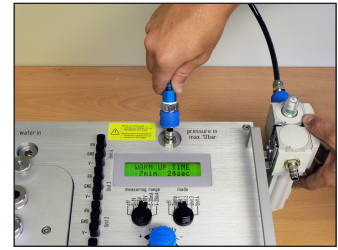

Connect the pressurised (min. 8 bar) compressed air line to the filter set. A supply pressure less than 8 bar can cause leakage at the filter set. ($p \leq 10$ bar - see safety instructions)



Humor 20 is ready for operation.



6.3 Starting up Humor 20 with automatic calibration module

Setting up Humor 20 with the automatic calibration module.



Humor 20 must acclimatise at least 6 hours on-site at the calibration location.



Establish a serial connection between Humor 20 and the automatic calibration module. Connect "RS232-Humor" on the automatic calibration module with "RS232" on Humor 20. (Max. cable length allowed is 3 m. The length of the supplied cable is 1.8m)



Connect the power cable to a grounded power outlet, but do not switch on the devices yet, using the main switch!



Establish a serial connection between the automatic calibration module and the PC/notebook.



First switch on Humor 20 using the main switch and then the automatic calibration module.



Open the water tank. Ignore the warm-up time.
Use the Allen key supplied to open the screw plug.

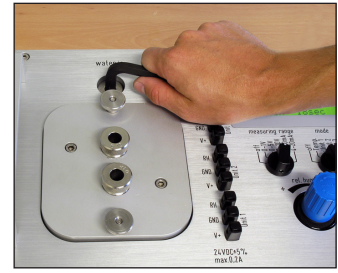

Before opening the water tank, make sure that the humidity calibrator is no longer under pressure. Turn the humidity controller to the left (anti-clockwise) as far as it will go and wait until "RH > 90 %" is shown in the display of Humor 20.

Fill Humor 20 with distilled water.
Fill the humidity calibrator with max. 1000 ml distilled (deionised) water.
If the maximum level is exceeded, the warning WATERLEVEL HIGH is shown in the display. If this happens, drain water until the warning disappears (see section "9.2 Drain water").

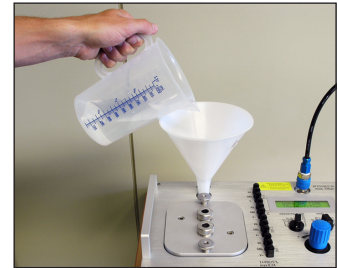

During the filling process, make sure that no water enters the measuring chamber.

Close the water tank.
Use the Allen key supplied to tighten the screw plug.

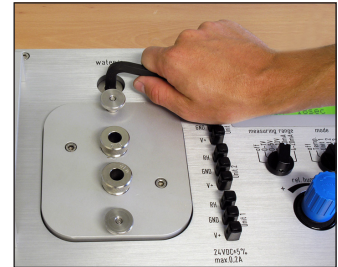

Wait until the warm-up phase is completed.
The warm-up phase will take 20 minutes (display: WARM UP TIME).



Establish a compressed-air connection between Humor 20 and the automatic calibration module.



Max. allowed hose length is 1 m.

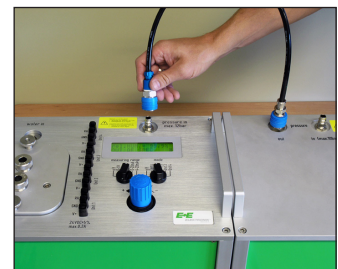

Attach the oil separator to the side of the automatic calibration module, on the bracket, and establish a connection to the input "Pressure in".

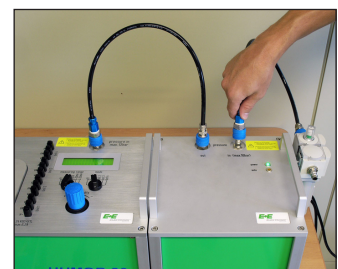



Connect the pressure supply (oil-free compressed air or N2).
A supply pressure less than 8 bar can cause leakage at the filter set.
($p \leq 10$ bar - see safety instructions)

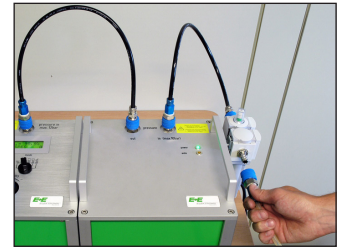

Turn the humidity controller to the right (clockwise) as far as it will go.

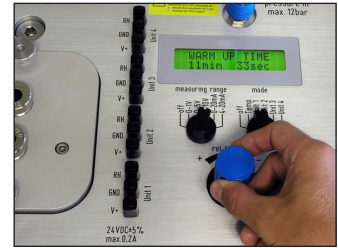

Humor 20 with the automatic calibration module is ready for operation.

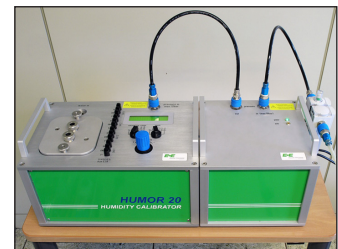

6.4 Verifying the 100 % RH Point

To obtain the highest accuracy of the humidity measurement it is recommended to verify the 100 % RH point every 4 weeks during continues operation or each time before putting the Humor 20 into operation.

The verification has to be executed as follows:

- Turn the humidity controller counterclockwise all the way
- Disconnect the air pressure supply to the Humor
- Display reading > 95 % RH
- Open the water inlet
- Open the measuring chamber (one opening is sufficient, see picture)
- Read the display after approx. 5 minutes:



Display reading	Final conclusion on performance	Required action
99.2 % to 100.8 %	Humor within specifications	A high accurate measurement can be realized
97.0 % to 99.2 % and 100.8 % to 103.0 %	Humor outside specifications	Adjustment is necessary to obtain the highest accuracy (see chapter "8.3.2. Calibration").
< 97.0 % and >103.0 %	Humor outside specifications	Adjustment is not possible. There is a problem with the humidity measurement / indication and the Humor should be returned to E+E Elektronik for calibration / repair.

7. CALIBRATION AND ADJUSTMENT PROCEDURE



TERMINOLOGY:

Calibration = verification / checking

Adjustment = modification / tuning

The special design of the measuring chamber allows the calibration and adjustment of transmitters of varying sizes. These include cylindrical sensor probes with a diameter of 8-25.5 mm (0.3-1") (hand-held instruments, duct-mounted versions, ...) and room transmitters, data loggers, etc. with maximum dimensions of 100 x 85 x 40 mm (3.9x3.3x1.6") or 95 x 95 x 40 mm (3.7x3.7x1.6").

7.1 Cubical transmitters (room design) with Humor 20

Humor 20 can also be used to calibrate and adjust room devices using the Plexiglas cover for the measuring chamber provided in the scope of supply.

Due to external thermal interference, additional measuring errors may occur depending on the adjusted humidity and the position of the test unit in the measuring chamber.



1. Place the test unit in the measuring chamber.
2. Lay the O-ring for the Plexiglas cover in the groove provided in the measuring chamber.
3. Feed the connection cable through the PG screw connection of the Plexiglas cover.
4. Fit the cover and tighten both knurled nuts.
5. Connect the test unit to the supply connections of Humor 20.
6. Connect the output signal of the test unit to the internal measuring inputs of Humor 20 (Unit1 RH, Unit2 RH)
7. Select the measuring range in accordance with the output signal of the test unit. The temperature of the measuring chamber can be displayed by selecting "Temp." on the measuring range switch.
8. For information on the standard deviations and stabilisation times of the test unit, refer to the manufacturer's documentation (however, a minimum of 20 mins is recommended).
9. Use the controller to select the setpoint of the humidity.
10. Compare the values shown in the display with the output signal of the transmitter.

7.2 Transmitter with sensor probe with Humor 20

Because of the operating principle, Humor 20 has a slightly higher temperature than ambient. During the measurement process, make sure that the probe temperature can adapt to the temperature of the measuring chamber.

To ensure accurate measurements, the cover feedthrough must match the probe diameter as closely as possible. To ensure that this is the case, various cover designs are available (see the accessories appendix).



1. Fit a suitable measuring chamber cover (note the position and diameter of the feedthrough) and tighten both knurled nuts. If inserted, remove the O-ring for the Plexiglas cover.
2. Insert the test unit(s) through the feedthrough(s) in the measuring chamber and tighten the screw connection(s).



If using the modules EE07 and EE08 (with cables) please note that only the filter caps get into the measuring chamber of the Humor to avoid falsification of the calibration through self heating effects (see picture on the left).

3. Seal the openings of the feedthroughs not in use with the supplied plugs.
4. Connect the test unit(s) to the supply connections of Humor 20 (24 V DC).

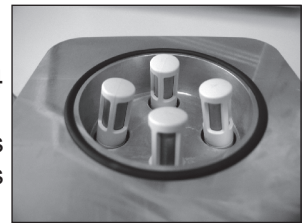

Make sure that the total power consumption of all transmitters is not more than 200 mA. In case the transmitters exceed this maximum, an external power supply has to be provided.

5. Connect the output signal of the test unit(s) to the internal measuring inputs of Humor 20 (Unit1 RH, Unit2 RH, Unit3 RH, Unit4 RH).
6. Select the measuring ranges in accordance with the output signal of the test units. The temperature of the measuring chamber can be displayed by selecting "Temp." on the measuring range switch.
7. Use the humidity controller to select the setpoint of the humidity.
8. For information on the standard deviations and stabilisation times of the test unit, refer to the manufacturer's documentation (however, a minimum of 20 mins is recommended).

9. Compare the values shown in the display with the output signal of the transmitter.

7.3 Transmitter EE33 Model J with Humor 20

To be able to calibrate the transmitter of the series EE33-MFTJ, with the dual probes (Td-probe and T-probe), a separate available adapter is needed (see chapter 12 'accessories' – adapter for EE33 – model J, part number HA020401) to achieve the highest possible calibration result. The following steps describe how the series EE33-MFTJ should be calibrated correctly.

1. Plug both air vents of the cover of the measurement chamber with the plugs supplied with the adapter (see left picture).
2. Insert the Td-probe (Ø12 mm) in the measuring chamber through one of the feed-throughs of the cover and tighten the nut.
3. Insert and tighten the T-probe (Ø6 mm) in the adapter and insert in the measuring chamber through one of the feed-throughs of the cover and tighten the nut.

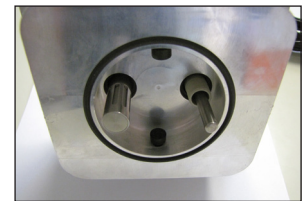

4. In case that feed-throughs are not in use, close them with the blind plugs delivered with the cover. Transmitters delivered after June 2009 have the possibility to heat the tube of the probe continuously to avoid condensation. This function must be disabled prior to calibration, by detaching the cover of the transmitter and removing the "heat"-jumper in the left top corner of the PCB (see left picture).



5. Connect the test unit to the supply connections of Humor 20.
6. Connect the output signal of the test unit(s) to the internal measuring inputs of Humor 20 (Unit1 RH, Unit2 RH).
7. Select the measuring ranges in accordance with the output signal of the test units. The temperature of the measuring chamber can be displayed by selecting "Temp." on the measuring range switch.
8. Use the humidity controller to select the setpoint of the humidity.
9. For information on the standard deviations and stabilisation times of the test unit, refer to the manufacturer's documentation (however, a minimum of 20 mins is recommended).
10. Compare the values shown in the display with the output signal of the transmitter.



After calibration, make sure that the plugs in the air vents in the cover of the measuring chamber are

removed.

7.4 Analogue Output Humor 20

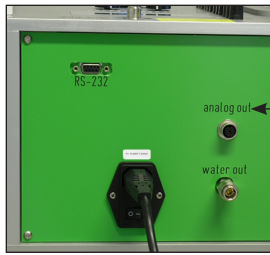

On the back panel of the Humor 20 sits a 4-pole connector with the label “analog out”.

Here are the conditions of the measuring chamber (RH, T) reproduced in the form of an analog signal.

Contact-Nr	Signal	Scaling
1	GND	
2	not connected	
3	RH_out	0-10V = 0-100 % RH
4	T_out	0-10V = 0-50 °C

Plug Connection:

7.5 Calibration with the automatic calibration module



see section “8.4 Measurements”.

7.6 Power failure during the calibration procedure

Humor 20

In the event of longer power failures (> 5min.), unlock (pull out) the controller's rotary knob and turn it anticlockwise as far as it will go. Disconnect the media supply. Once the power returns and the warm up phase has been completed, the calibration process can be resumed.

Humor 20 with the automatic calibration module

In the event of a power failure, an error message is displayed (see screenshot) and the calibration

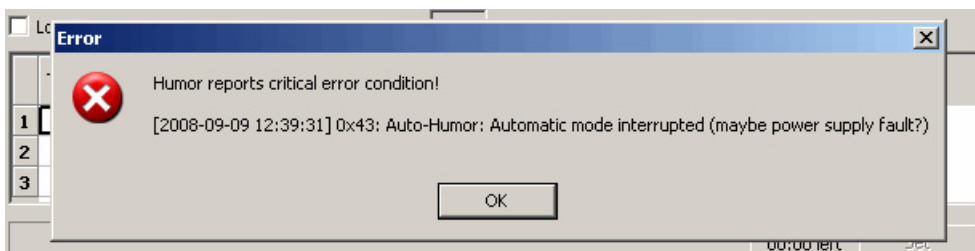

must be restarted.



If longer idle periods are expected, it is recommended to empty the distilled (deionised) water tank completely.

For more information, see section "9.2 Drain water".

Remove the supply pressure (compressed air) and turn off the main switch (if applicable, disconnect the grounding plug).

7.7 Ending the calibration or adjustment procedure

8. HUMOR 20 SOFTWARE

This software was developed by E+E Elektronik® in order to adapt the humidity calibrator Humor 20 to customer requirements, to log measured values, and to register the data in an adjustable measurement protocol.

8.1 Installation the software

1. Insert the CD-ROM supplied into your PC drive.
2. Close all other active programs.
3. Double-click on the file "Setup.exe".
4. Follow the instructions in the context menu.

Once Humor 20 is connected to the PC via the serial interface and the software is started, the

Procedure:

1. Select language.

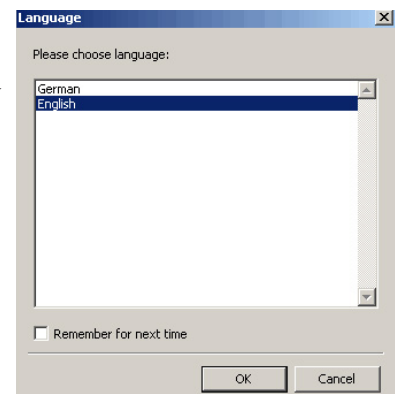

2. Select the COM Port. Changes can be made at any time in the menu under "Operation" - "Select COM Port".

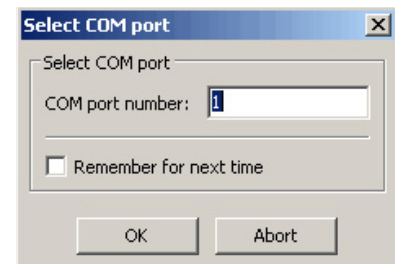

3. Start screen:

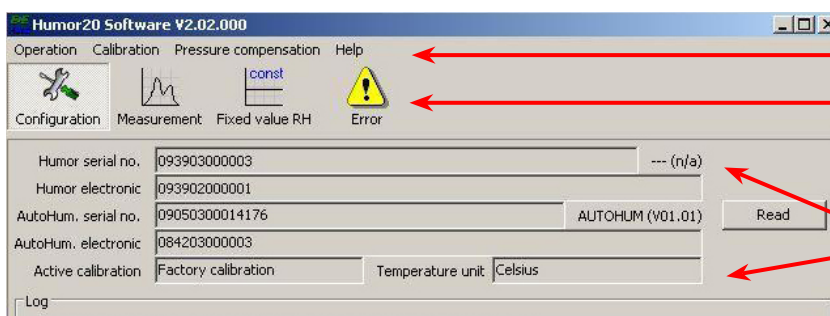

Menu bar

Buttons to switch the control panels for the various operating modes

Control panel

On starting the software, the configuration modes starts automatically and the serial numbers and status of Humor 20 and the automatic calibration module are loaded.

alongside input windows appear.

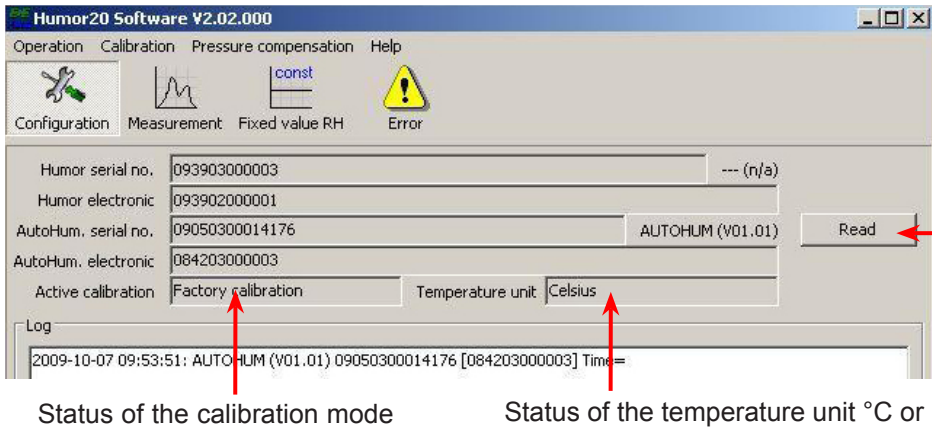

8.2 Configuration mode control panel

The serial numbers and status of Humor 20 and the automatic calibration module are loaded.

Status of the calibration mode

Status of the temperature unit °C or °F

8.3 Menu bar

8.3.1 Operation

The pull-down menu "Operation" includes all the functions required to configure the humidity calibrator in accordance with customer requirements and to exit the program.

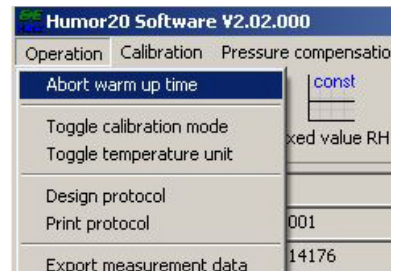

Abort warm up time:

Aborts the warm up phase (20 mins).

The warm up phase is essential in order to achieve very accurate measuring results.

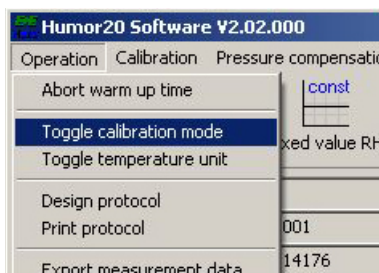

Toggle calibration mode
The humidity calibrator can be switched between factory calibration and customer calibration. The current mode is displayed in the status bar of the software and in the status bar of the calibrator.



"F" (Factory)
mode. Users can switch between factory and customer calibration. The current mode is displayed in the start menu of the software and in the status bar of the calibrator.

"C" (Customer)

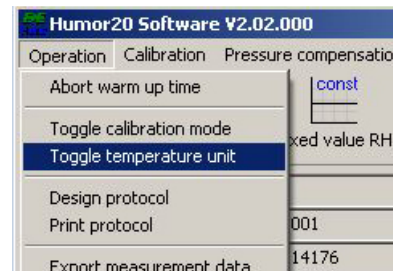

Design protocol:

In addition, the Humor 20 software provides the option of automatically generating a measurement protocol.

A ready-made template is defined and on completion of the measurement filled out automatically with the calculated values. Immediately after the end of the measurement process, a protocol in a well-organized format can be generated at the touch of a button.

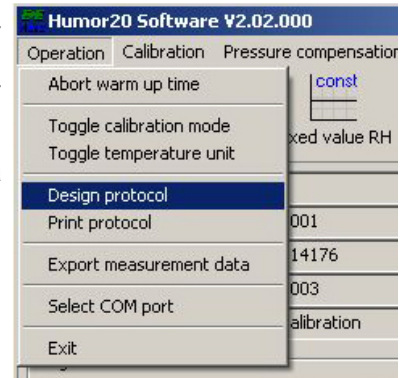

E+E Elektronik offers a ready-made standard template that opens automatically on selection of the function "Design protocol". This standard template can easily be altered to meet customer requirements.

To create a fully customer-specific layout for the measurement protocol, the help text for the protocol designer has to be read carefully because of the wide range of options and functions. Therefore, the following approach is recommended:

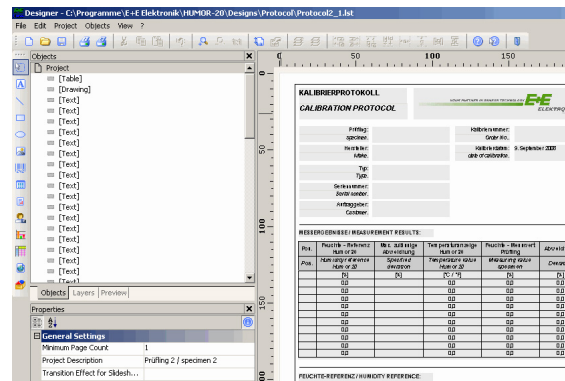

To minimize the effort to create the form / protocol, just change the text fields or logo of the standard template only.

To do so, choose "Save as" from the menu and save the standard protocol under a new file name of your choice.

To make sure that the standard template will no be changed, open the protocol designer again and choose the file just created and change it as desired.

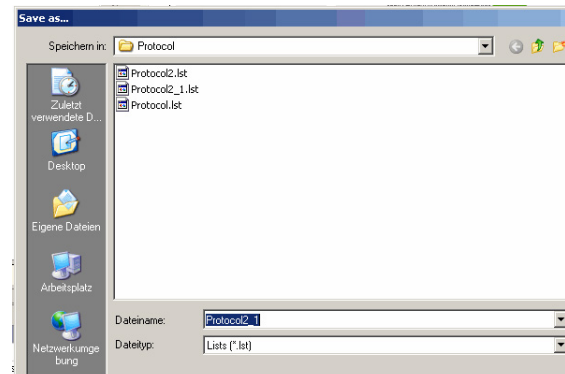

Changing the logo:

To enter your own logo in the protocol, select the placeholder (arrow 1). Your logo can be integrated in the protocol template by clicking on the specified path in the menu "Properties-Data-Source-File Name" (arrow 2).

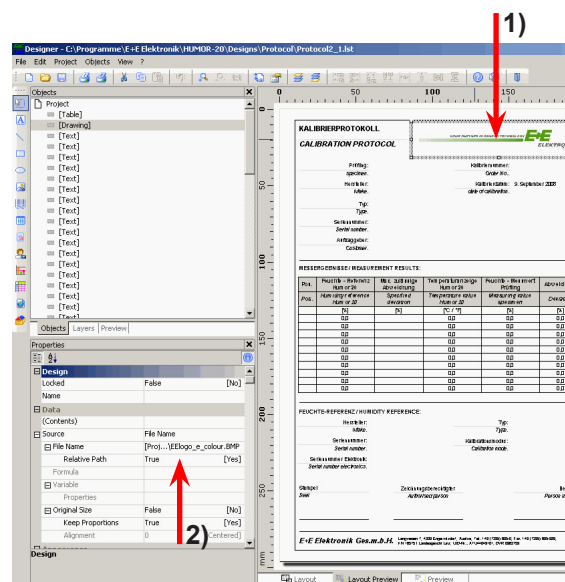

To simplify the design of your own measurement protocol, the list below provides an overview of the most important variables and fields as well as their content.

- Variables:** Contents can be incorporated directly into the form design.
Fields: Contents of fields can in addition be incorporated in every row of a table dependent on the number of measurement points (dynamic).

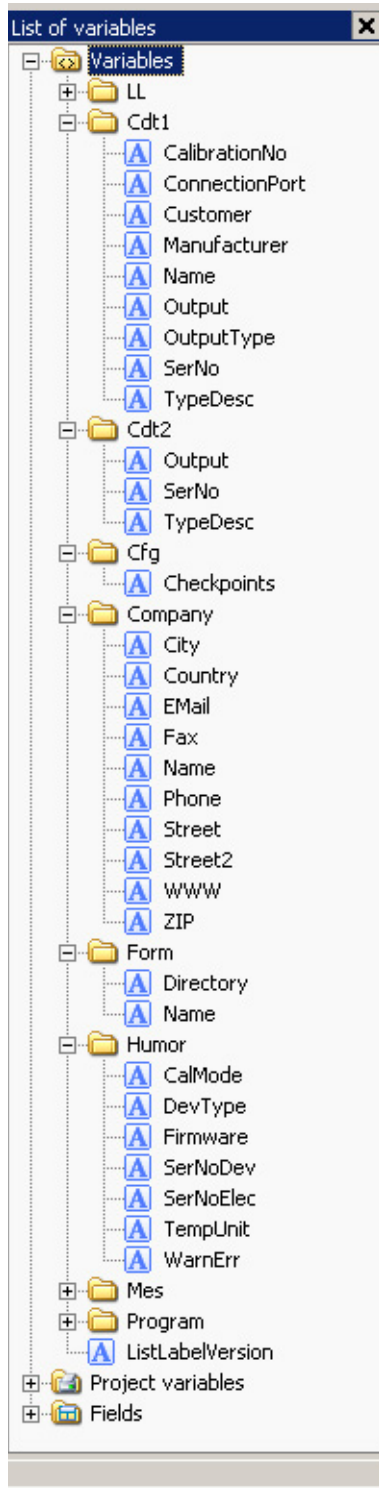

Variables: Their content can be added directly into measurement protocols.

- Candidate 1:
 Calibration number
 Connection port
 Customer
 Manufacturer
 Name
 Output signal
 Output analogue or manual
 Serial number
 Type

- Candidate 2, 3, 4:
 Output signal
 Serial number
 Type

Number of measurement points

Company: customer-specific data can be assigned with the following variables:

- City
 Country
 E-mail
 Fax
 Contact person
 Telephone
 Street
 Street 2
 Internet address
 Postcode

- Humor: the used Humor is described with the following variables
 Current operating state (Customer - / Factory Calibration)
 Type of device
 Firmware version
 Serial number of device
 Serial number of integrated electronics
 Used temperature unit °C / °F
 List of warnings and error messages

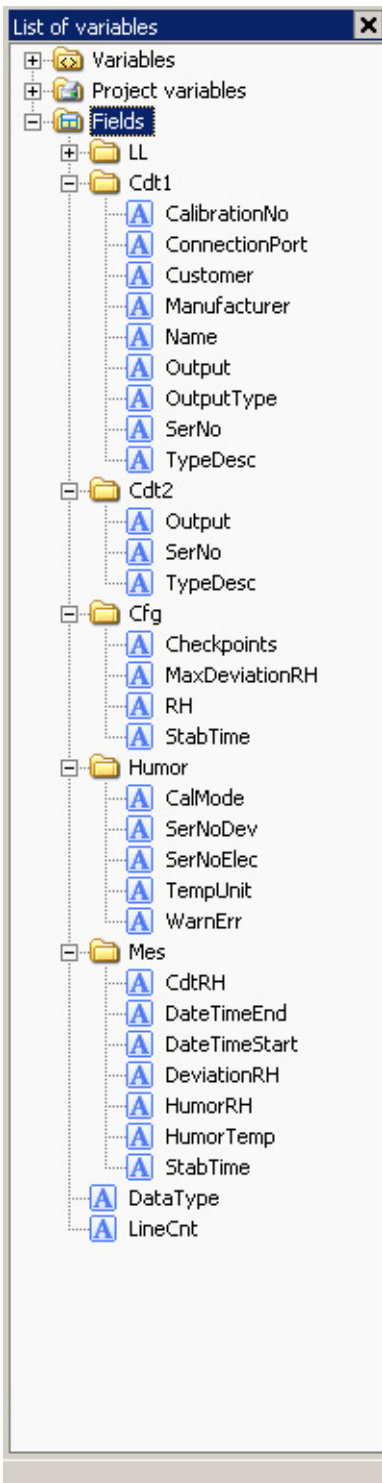

Fields: Their content can be inserted in dynamic tables of the measurement protocol

Candidate 1:

- Calibration number
- Connection port
- Customer
- Manufacturer
- Name
- Output signal
- Output analogue or manual
- Serial number
- Type

Candidate 2, 3, 4:

- Output signal
- Serial number
- Type

Configuration:

- Number of measuring points
- max. deviation RH (can be set)
- RH (setpoint)
- Stabilisation time (setpoint)

Humor: the used Humor is described with the following variables

- Current operating state (Customer - / Factory Calibration)
- Serial number of device
- Serial number of integrated electronics
- used temperature unit
- List of warnings and error messages

Determined measured values per measurement point:

- Measurement result candidate
- End of the stabilization time
- Start of the stabilization time
- Deviation of the candidate to the Humidity - reference value of the Humor 20
- Humidity - reference value - Humor 20
- Temperature - measured value Humor 20
- Stabilization time

Print protocol:

On completion of the measurement process, the measured values can be printed in a protocol.

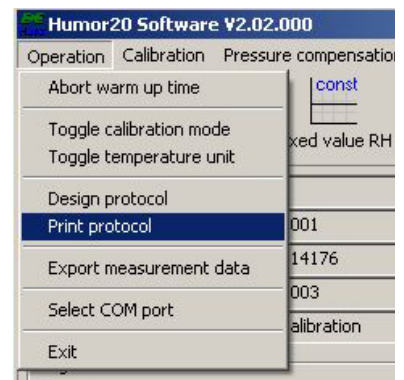

Use the command "Open" to choose between two pre-installed protocols.

If you have created your own protocol, this can also be selected here.

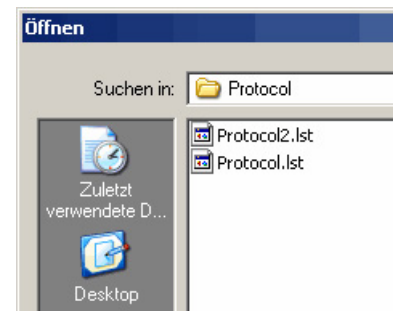

Export measurement data:

You can export the measurement data to Microsoft Excel®.

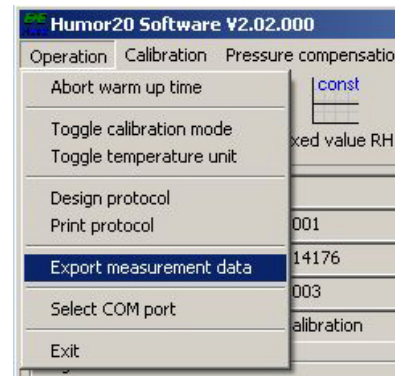

Select COM port:

You can use this function to change the COM port.

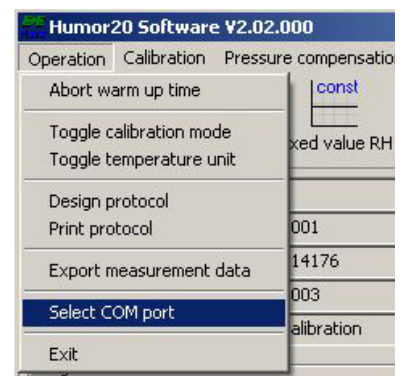

Exit:

The program is closed.

Temperature calibration:

Only possible in the "CUSTOMER calibration" mode.
The temperature is equalised with a temperature standard.



A stabilisation time of 2h is recommended.

1. Insert an external temperature standard into the measuring chamber.
2. Enter the reference value in the input field.
Important: Temperature must be within the range $23\text{ °C} \pm 10\text{ °C}$.
3. With "Store" the adjusted temperature value is implemented.

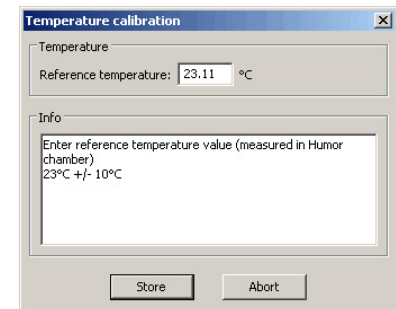
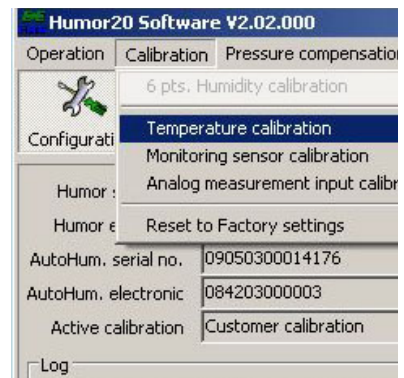

Monitoring sensor calibration:

Only possible in the "CUSTOMER calibration" mode.
This function can be used to adjust 2 points of the humidity transmitter integrated in Humor 20 for monitoring purposes.

Procedure:

1. Acclimatise Humor 20 to the ambient conditions (temperature homogeneity).
2. Humor 20 should run for an additional 2 hours after the warm up phase.
3. Set the lower setpoint to 30 % RH.
4. Once the stabilisation time has expired (30 mins), equalise the "Monitoring Sensor" to the reference value of Humor 20.
5. Set the upper setpoint to 70 % RH.
6. Once the stabilisation time has expired (30 mins), equalise the "Monitoring Sensor" to the reference value of Humor 20.

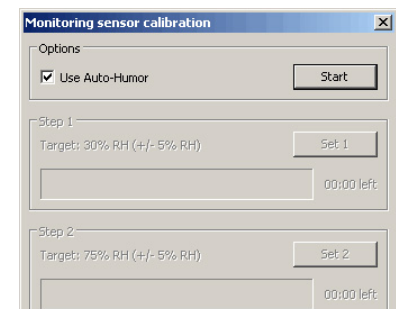
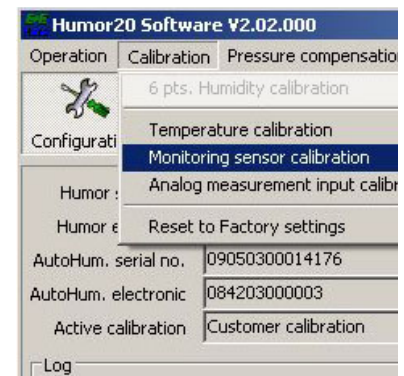

Analog Measurement Input Calibration:

With this function, the analog measurement inputs of the Humor 20 (1-4) can be checked:

1. Select with Switch1 (see 6.1) either a current or a voltage range.
2. Select with Switch 2 (see 6.1) the measurement input to be tested.
3. Connect the external signal source with the selected Humor 20 measurement input (1-4).
4. Set the analogue signal from the external source (0 – 10 V or 0 – 20 mA)
5. In the display the measured value will be indicated.

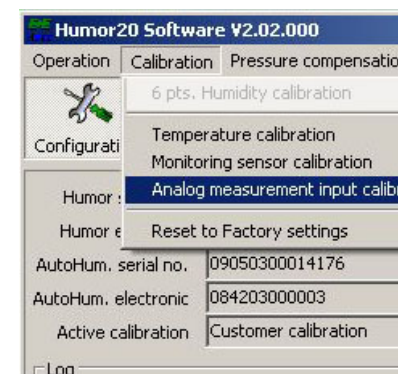

Reset to Factory settings:

All of the adjustment's calibration data is reset to the factory calibration default values.

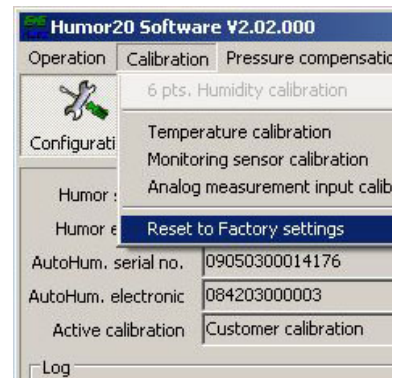

Toggle temperature unit:

The temperature is set to SI or U.S. engineering units for the temperature to be displayed in degrees Fahrenheit or degrees Celsius.

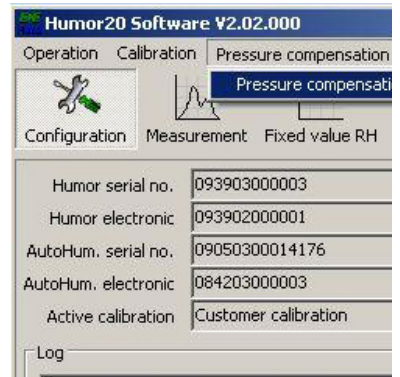

8.3.2 Adjustment / Calibration

8.3.3 Pressure Compensation

This function is used to equalise the two pressure transmitters of Humor 20.

For accurate measurements, the equalisation should be performed every 4 weeks.

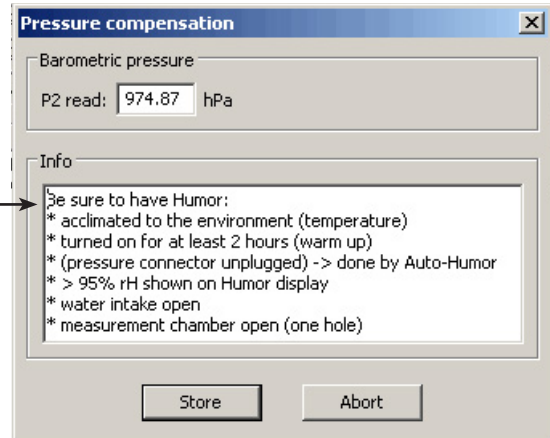

Follow the instructions in the info field and press the button "Store".

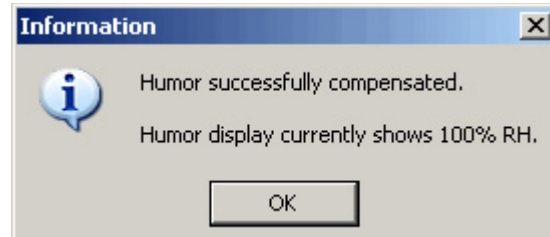

Once the equalisation is complete, check that "100% RH" is shown in the Humor 20 display.

$$RH = \frac{p_2}{p_1} \times 100\% = \frac{978,7 \text{ hPa}}{978,7 \text{ hPa}} \times 100\% = 100\%$$

Mode of operation:

The offset of the absolute pressure transmitter in the saturation chamber P_1 (0-10 bar) is aligned to $P_2 = P_{\text{Reference}}$ in the measuring chamber.

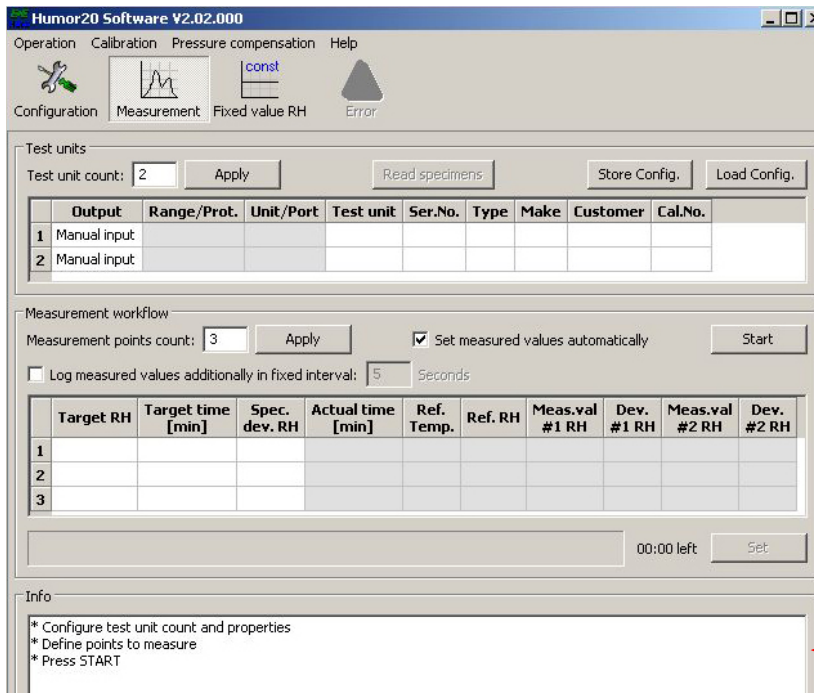

Transmitters P₁ and P₂ are now aligned to the atmospheric pressure. A alignment has been performed at 100 % RH.

8.4 "Test units" configuration field

Measurements

8.4.1 "Measurements" configuration field
Start screen

Info field

8.4.2 "Test unit" configuration field

Enter the number of test units to be measured in the "Test unit count" field and confirm your configuration for each test unit.

Output:

Here you choose how the test unit's measured value should be entered:

Manual input: Once the stabilisation time has expired, the measuring program waits until the measured value is entered manually. Press "Set" to confirm your entry.

Analogue (Humor20): Once the stabilisation time has expired, the measured value is adopted automatically by the measuring input of Humor 20.

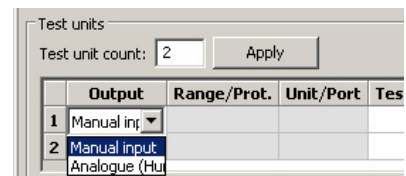

Range/Prot.:

[Only active with the "Analogue (Humor20)" output]

Here, you select what the output signal of the test unit is.

Do not mix up voltage and current measurement!

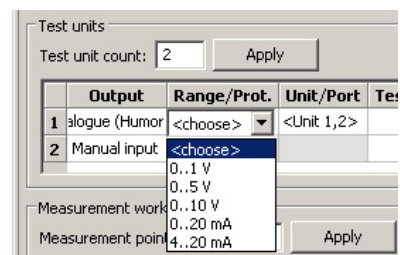

Unit/Port:

[Only active with the "Analogue (Humor20)" output]

Select the measuring input (Unit 1 - Unit 4) used to connect the test unit to Humor 20.

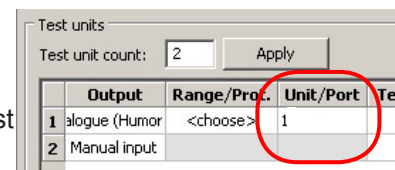

Note: the rotary knob of the Humor 20 has to be set at the correct measurement input as well, to indicate desired measurement value in the display.



Test unit / Ser.No / Type / Make / Customer / Cal.No:

Test units

Test unit count:

	Output	Range/Prot.	Unit/Port	Test unit	Ser.No.	Type	Make	Customer	Cal.No.
1	alogue (Humor	0..10 V	1	EE08-PFT3D6T02	000977865	RH/T	E+E	Mustermann	K000978
2	alogue (Humor	0..10 V	2	EE08-PFT3D6T02	000967865	RH/T	E+E	Mustermann	K001000
3	alogue (Humor	0..10 V	3	EE08-PFT3D6T02	000988888	RH/T	E+E	Mustermann	K000002

Test unit:

Enter the type designation of the test unit here.
This field can be included in the protocol.

Ser.No:

Enter the serial number of the test unit here.
This field can be included in the protocol.

Type:

Enter the type of the test unit here.
This field can be included in the protocol.

Make:

Enter the make of the test unit here.
This field can be included in the protocol.

Customer:

Enter the name of the customer here.
This field can be included in the protocol.

Cal.No:

Enter the calibration number (your internal number) for the job.
This field can be included in the protocol.

You can save the configuration for the test unit(s) by pressing the "Store Config." button.
To load a stored configuration, choose "Load Config."

8.4.3 "Measurements" configuration field

	Target RH	Target time [min]	Spec. dev. RH	Actual time [min]	Ref. Temp.	Ref. RH	Meas.val #1 RH	Dev. #1 RH	Meas.val #2 RH
1									
2									

Measurement points count:

Enter the number of measurement points and confirm your entry by pressing "Apply".

Set measured values automatically:

Checkbox selected: The test unit's measured value at the measuring input of Humor 20 is set automatically once the stabilisation time has expired.

Checkbox not selected: The program waits for the measured value to be entered manually once the stabilisation time has expired.

Log measured values additionally in fixed interval:

If you select this checkbox, the test unit's measured values will be logged by the measuring input of Humor 20.

The measured values are stored in the file "MeasLog.csv" in the program directory of the Humor 20 software.

	Target RH	Target time [min]	Spec. dev. RH	Actual time [min]	Ref. Temp.	Ref. RH	Meas. #1 RH
1	10	00h 45min	3				
2	15	00h 30min	3				
3	20	00h 30min	3				
4	30	00h 30min	3				
5	50	00h 30min	3				

Now you can set the measurement points:

Target RH:

Enter the humidity value of the measurement point, e.g. 20 for 20 % RH.

Target time [min]:

Enter the required stabilisation time in minutes (e.g. 20 for 00 h 20 min or 80 for 01 h 20 min).

Spec. dev. RH:

Enter the permitted tolerance for the measurement point. You can only enter numerical values (e.g. 2 for ± 2 % RH).

Once all the measurement points have been fully configured, you can start the measurement by pressing the "Start" button.



If using an automatic calibration module, turn the humidity controller to the right (clockwise) as far as it will go, refer to chapter 6.3.

The automatic calibration module now adjusts to the first measurement point.

During this adjustment procedure, the orange LED "auto" on the automatic calibration module flashes. Once the setpoint has been reached, the LED lights up continuously.

If the measurement point is reached within a range of ± 1 % RH, the stabilisation time for the measurement point begins to run. Once the stabilisation time has expired, depending on whether the checkbox "Set measured values automatically" has been selected, either the system enters the value of the measuring input of Humor 20 or waits for a manual entry.

	Target RH	Target time [min]	Spec. dev. RH	Actual time [min]	Ref. Temp.	Ref. RH	Meas. #1 RH
1	10	00h 45min	3	00h 00min	23.24	9.63	
2	15	00h 30min	3				
3	20	00h 30min	3				
4	30	00h 30min	3				
5	50	00h 30min	3				

Once the measurement is completed, the automatic calibration module adjusts the humidity to 40...60 % RH (orange "auto" LED goes out). The measured values are stored in the program directory

[...]\E+E Elektronik\HUMOR-20\MeasData].

The file name consist of the current date and time e.g. 2008-08-25_12_10_05.hmf



Note: If the measurement is aborted, no measured values are stored!

8.5 Fixed RH Value (only available when using an automatic calibration module)



The humidity control knob of the Humor 20 has to be turned to the right (clockwise) all the way to the stop, see chapter 6.3

Start Button:

as soon as the desired value is entered and the "Start-Button" is pressed, the desired humidity in the measurement chamber will be set by the Automatic Calibration Module (orange "auto" LED blinks or illuminates)

Stop-Button:

activating the "Stop-Button" will end the control of the Automatic Calibration Module (orange "auto" LED not illuminated); in this way, a humidity level of 10 % RH will be set in the measuring chamber of the Humor 20.

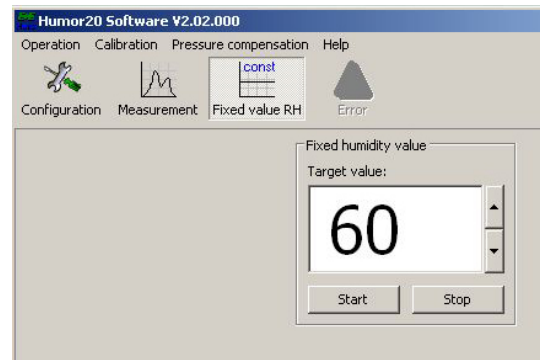

9. MAINTENANCE

The distilled (deionised) water should be changed every 8 weeks. If the unit is idle for longer periods, all the water should be removed.

9.1 Re-fill water (at error message - waterlevel low)

1. Turn the humidity controller all the way to the left and wait until the message "OUT OF SPEC" is displayed.
2. Remove the screw plug.
3. Fill with distilled (deionised) water (when the error message "Waterlevel low" is displayed, a max. of 750 ml can be added).
4. Replace the screw plug and tighten.
5. If the maximum fill level is exceeded, the error message "Waterlevel high" is displayed, and water must be removed until the message on the display disappears.
6. After filling, wait for a stabilisation time of around 20 mins (the higher the difference in temperature between the water and the humidity calibrator, the longer the stabilisation time ought to be).
7. Humor 20 is ready for operation.



9.2 Drain water (at error message - waterlevel high or long idle periods)

1. Turn the humidity controller all the way to the left and wait until the message rel.HUM high appears in the display.
2. If you are using the automatic calibration module, connect the compressed air supply directly to Humor 20.
3. Connect the water drain hose to the discharge nozzle.
4. Turn the humidity controller slowly to the right until water drains out.
 - a) Until the "Waterlevel high" message disappears.
 - b) Until the saturation chamber is completely empty. To make sure that the chamber is completely dry, flow air through the device for a short time.
5. To end the drainage process, turn the humidity controller to the left again as far as it will go.
6. Disconnect the compressed air and the water drain hose.
7. Humor 20 can now be turned off.

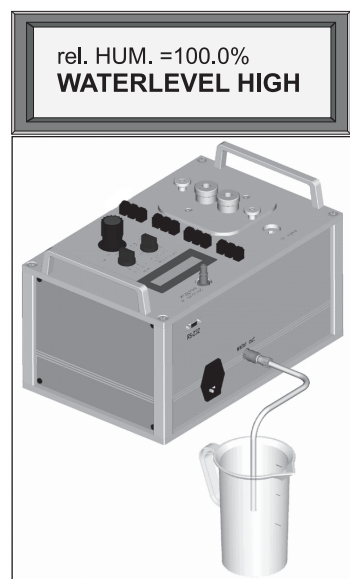

9.3 Cleaning

For cleaning the Humor 20 and automatic calibration module a dry drapery should be used.

10. WARNINGS / ERROR MESSAGES ON THE DISPLAY

1st line: Displays moisture () or error ()

2nd line: Status bar () and actual value of the test unit on Humor 20



The humidity calibrator is equipped with an auto diagnostic system. It issues different operating or error messages depending on the operating status or error. You can remedy the cause of the messages as follows:

CAUSE

REMEDY

10.1 Humidity - display flashes

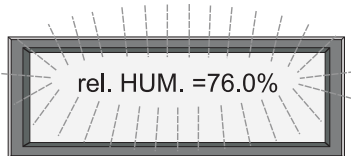

1. After a sudden change in the setpoint, the measuring chamber has not reached the desired value immediately. As soon as the difference between the relative humidity shown in the measuring chamber and the setpoint exceeds a defined range, the display starts to flash.

2. Water in the measuring chamber or internal lines.

This error is usually caused by transporting a Humor 20 device filled with water or connecting compressed air when the humidity controller has not been turned all the way to the left.

Wait for the stabilisation time to end (after a few minutes, the display should stop flashing automatically).

Dry the measuring chamber with an absorbent cloth. Drain the water, and let compressed air or nitrogen flow through the device for a lengthy period. This is achieved by specifying a setpoint of 75 % on the humidity controller. During the purging (drying), the display flashes and the warning WATERLEVEL LOW is shown. The drying process lasts around 48h and should be monitored by a test unit. The drying process is complete as soon as the test unit shows a relative humidity of < 15%.

This process can be accelerated by using dry compressed air or dry nitrogen.

10.2 Warning: OUT OF SPEC



A humidity setpoint > 95 % RH was specified or < 10 % RH was selected.

Device is operated outside of the working range.

10.3 Warning: WATERLEVEL HIGH

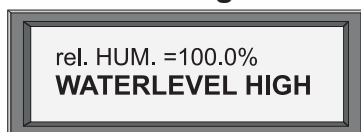

The maximum fill level for distilled (deionised) water has been exceeded.

Empty water until the warning disappears.

10.4 Warning: WATERLEVEL LOW



The water level is below its minimum.

Add distilled (deionised) water.

10.5 Error message: heat defect

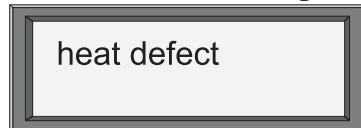

Humor 20 has not reached its operating temperature.

Contact your E+E Elektronik sales partner.

10.6 Error message: pressure excess

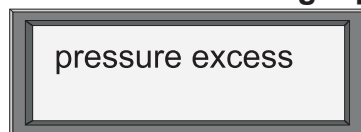

A humidity setpoint < 8 % RH was selected. The humidity calibrator may have been damaged by the high pressure. The specified accuracy cannot longer be guaranteed.

Contact your E+E Elektronik sales partner.

10.7 Humidity - display is incorrect

Incorrect display, e.g. because of an error in the electronics.

Check Humor 20.

Turn the controller to the left as far as it will go and disconnect the compressed air. After a stabilisation time of 2 h, the display should show 100 ±2 % RH. If this is not the case, contact your E+E Elektronik sales partner.

10.8 Stabilisation time too long

Valve defect.

Check the flow.

1. Drain all the water completely and refill the humidity calibrator with exactly 1000 ml of distilled water.
2. Specify a humidity setpoint of exactly 20 % RH.
3. Turn the humidity controller all the way to the left and measure the time it takes for the value 80 % RH to appear in the display.
 - If the time measured is < 80 sec, the flow is correct and within the working range.
 - If the process takes much longer, contact your E+E Elektronik sales partner.



The response time of Humor 20 for a jump in humidity from 25 to 80 % RH and from 80 to 25 % RH is shown in the graph. A jump to a lower value requires approx. 1 minute, while a jump to a higher humidity value requires approx. 3 minutes.

The required stabilisation time is determined primarily by the test unit.

Considering the response times of instruments now available on the market (equipped with standard filters), a stabilisation time of approx. 20 minutes / measurement point can be expected.

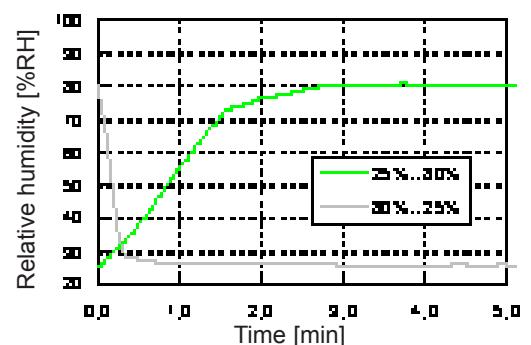

10.9 Leakage in filter set

CAUSE

You will hear if there is a leakage in the filter set (escaping air).

REMEDY

Disconnect the compressed air supply and check the pressure. Make sure the supply is at least 8 bar. Reconnect the pressure supply.

10.10 Electronic defect - replace electronics

Replacing the electronics:

1. Disconnect the humidity calibrator from the supply voltage.
2. Loosen the screws (see Fig. 1).
3. Loosen the recessed-head screws on the 19" rack (see Fig. 2).
4. Pull out the plug-in module (electronics) (see Fig. 3).
5. Insert the replacement electronics and close the housing.
6. Calibrate Humor 20.

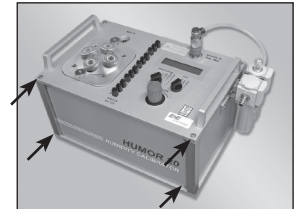

Fig. 1

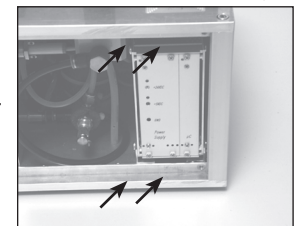

Fig. 2

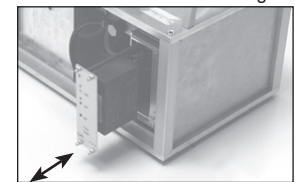

Fig. 3



The factory calibration is lost when the electronics are replaced! If you have any questions, please contact your E+E Elektronik sales partner.

10.11 Fuse defect - Replacing the fuse (Humor 20 + Autokit)

Replacing the fuse:

1. Disconnect the humidity calibrator from supply voltage.
2. Open bracket (see Fig. 1).
3. Remove fuse (see Fig. 2).
4. Insert new fuse (Type: 6,3x32 mm F1: 1A 250 V T (slow) - Note the arrow direction (see Fig. 3)).
5. Close bracket.
6. Calibrate Humor 20.



Fig. 1

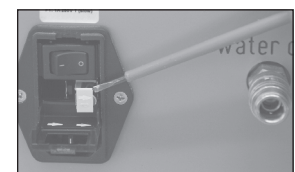

Fig. 2



Fig. 3



If you have any questions, please contact your E+E Elektronik sales partner.

11. TECHNICAL DATA

General

Function principle	two-pressure-reactor
Working range	10...95 % RH
Protection class	I
Protection type	IP40
Surge voltage category	II
Installation altitude	up to 2000 m above sea level
Application	Indoors

Accuracy of measurement^{1) 2)}

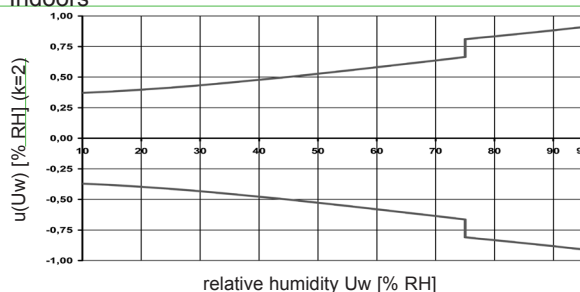

Accuracy temperature measurement in measuring chamber²⁾

typ. ± 0.3 °C (± 0.54 °F)

Power supply 100...230 V AC, 50/60 Hz, max. 20 W

Work equipment • compressed air, filtered and free of oil or nitrogen N₂ with max. 10 bar (145 psi)

• distilled water

Stabilisation time Humor 20 < 3 min/measuring point

Stabilisation time specimen typ. 20 min/measuring point

Integrated power supply 24 V DC, max. 200 mA

Number of measuring inputs 4 (switchable between 4...20 mA / 0...20 mA / 0...1 V / 0...5 V / 0...10 V)

Typ. error for display inputs Voltage measuring: < 5 mV
Current measuring: < 30 µA

Display Dot-matrix display with backlight

Gas flow 3 l/min or RH > 85 % the gas flow is reduced to 1.5 l/min at 95 % RH

Recommended interval for recalibration 1 year

Interface for PC connection RS232 (COM-Port)

System requirements for software tools MS Windows 2000 mit SP 2 / Windows XP / Windows Vista

Environmental conditions temperature: 10...40 °C (50...104 °F)
humidity: 10...80 % RH

CE conformity EN61000-6-3:2007 EN61326-1:2006
EN61000-6-2:2006 EN61010-1:2010



Additional Standards EN60068-2-6 EN60068-2-29

Dimensions 400 x 260 x 240 mm (15.7 x 10.2 x 9.4")

Weight Humor 20: about 23 kg (51 lbs)
Humor 20 incl. aluminium transport case: about 36.5 kg (80.5 lbs)

Measuring Chamber

The construction of the measuring chamber allows the calibration and adjustment of cylindrical sensor probes with a diameter of 8-25.5 mm (0.3-1") (hand-held instruments, duct-mounted versions, ...) as well as of cubic measuring units (room transmitters, data loggers, ...) with maximum dimensions of 100 x 85 x 40 mm (3.9 x 3.3 x 1.6") or 95 x 95 x 40 mm (3.9 x 3.9 x 1.6").

By using the Plexiglas cover (standard supply), it is possible to calibrate and adjust compact room devices (e.g., the EE10) with the Humor 20.

The overall accuracy of the calibration is influenced by the absence of the metal cover. The additional error depends on the position of the specimen in the chamber as well as on the relative humidity.

1) The extended inaccuracy of measurement results from the standard inaccuracy increased by a multiplying factor of K=2.

2) Valid for metal covers for the measuring chambers

12. ACCESSORIES

12.1 Oil-free compressor

Technical Data:

Max. operation pressure	12 bar (174 psi)
Supply voltage	230 V AC // 50 or 60 Hz
Noise level	57 dB(A)/lm
Dimensions (l x w x h)	410 x 410 x 500 mm (16 x 16 x 20")
Weight	21 kg (46 lbs)



12.2 Covers for measuring chamber

Various covers for the measuring chamber accommodate probes of all diameters available on the market. With these covers up to four probes can be calibrated simultaneously.

SUITABLE FOR	NUMBER OF FEEDTHROUGHS	ORDER-CODE
Humor cover 12 - 16 mm (0.5 - 0.6") plane	for 2 Probes	HA020201
Humor cover 16 - 20.5 mm (0.6 - 0.8") plane	for 1 Probe	HA020202
Humor cover 20.5 - 25.5 mm (0.8 - 1") plane	for 1 Probe	HA020203
Humor cover 8 - 12 mm (0.3 - 0.5") plane	for 3 Probes	HA020204
Humor cover 12 - 13 mm (0.5 - 0.52") conic	for 4 Probes	HA020205
Humor cover für Humlog 10	for 1 Probe	HA020206
Humor cover 12 - 16 mm (0.5 - 0.6") bevelled	for 4 Probes	HA020207
Humor cover 16 - 20.5 mm (0.6 - 0.8") bevelled	for 4 Probes	HA020208
Humor cover 30 mm (1.2") plane	for 1 Probe	HA020409
Adapter for EE33 - modell J ¹⁾		HA020401

12.3 Calibration certificate

To meet the requirements of Quality Management Systems such as ISO9001 regarding calibration and certification of measurement and test instrumentation, the Humor 20 is available with an official OEKD accredited calibration certificate.



12.4 Automatic calibration module

For the fully automatic measurement of the characteristics of a transmitter.

Technical Data:

Weight	- weight of instrument: 9 kg (20 lbs) - instrument incl. aluminium transport case: 23kg (51 lbs)	
Dimensions	260x260x240 mm (LxBxH); (10.2"x10.2"x9.4")	
Supply	100...230 V AC, 50/60 Hz max. 15 W	
Interface to PC	RS232 (COM Port)	
Compressed air supply	min. 9.8 bar (142 psi); max. 12 bar (174 bar); filtered oil-free compressed air, max. size of particle: 5 µm	
Protection type	IP40	
Protection class	I	
Pollutional index	2	
Surge voltage category	II	
Installation altitude	up to 2000 m above sea level	
Application	Indoors	
CE conformity	EN61000-6-3:2007 EN61000-6-2:2006	EN61326-1:2006 EN61010-1:2010
Additional Standards	EN60068-2-6	EN60068-2-29

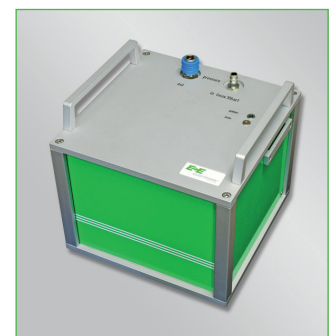

DECLARATION OF CONFORMITY

(According to ISO/IEC 17050-1)

Product(s) Type	From Version:	Measure:
HA020301	030702_1 030203_1 030703_1	Automatic Calibration Module for HUMOR

CE
E+E ELEKTRONIK Ges.m.b.H.
Langwiesen7
A-4209 Engerwitzdorf / AUSTRIA

We declare under our sole responsibility that this product(s) (see product table above) corresponds to the following regulations and their subsequent modifications:

Directive Ref.	Directive area
2004/108/EC	Electromagnetic compatibility
2006/95/EC	Low voltage equipment
2011/65/EC	RoHS

The products conform with the following standards or standardized documents:

Standard	Year of ratification
EN 61000-6-2	2006
EN 61000-6-3	2007
EN 61326-1	2006
EN 61010-1	2010

Affixing of the CE marking (for the first time): 2008

Test Report: Ce-Conformity_AutoHum_02.doc
Modification: Standard update

Trinkl
DI Timethaler Wolfgang
(business manager)

Birkbauer
Engerwitzdorf, 27.05.2013
Birkbauer Martin
(chief EMC-lab)

File: Declaration_of_conformity_AutoHum_2.docx

DECLARATION OF CONFORMITY

(According to ISO/IEC 17050-1)

Product(s) Type	From Version:	Measure:
Humor 20 B	030702_1 030203_1 030902_1 030901_1 030903_1	Humidity generator

CE
E+E ELEKTRONIK Ges.m.b.H.
Langwiesen7
A-4209 Engerwitzdorf / AUSTRIA

We declare under our sole responsibility that this product(s) (see product table above) corresponds to the following regulations and their subsequent modifications:

Directive Ref.	Directive area
2004/108/EC	Electromagnetic compatibility
2006/95/EC	Low voltage equipment
2011/65/EC	RoHS

The products conform with the following standards or standardized documents:

Standard	Year of ratification
EN 61000-6-2	2006
EN 61000-6-3	2007
EN 61326-1	2006
EN 61010-1	2010

Affixing of the CE marking (for the first time): 2002

Test Report: Ce-Conformity_Humor20_B_02.doc
Modification: Standard update

Trinkl
DI Timethaler Wolfgang
(business manager)

Birkbauer
Engerwitzdorf, 27.05.2013
Birkbauer Martin
(chief EMC-lab)

File: Declaration_of_conformity_Humor20_B_3.docx

HEAD OFFICE:

E+E ELEKTRONIK Ges.m.b.H.

Langwiesen 7
A-4209 Engerwitzdorf
Austria
Tel: +43 7235 605 0
Fax: +43 7235 605 8
info@epluse.com
www.epluse.com

SALES OFFICES:

E+E CHINA / BEIJING

Tel: +86 10 84992361
info@epluse.cn www.epluse.cn

E+E CHINA / SHANGHAI

Tel: +86 21 61176129
info@epluse.cn www.epluse.cn

E+E GERMANY

Tel: +49 6172 13881 0
info@epluse.de www.epluse.de

E+E FRANCE

Tel: +33 4 7472 35 82
info@epluse.fr www.epluse.fr

E+E ITALY

Tel: +39 02 2707 8636
info@epluse.it www.epluse.it

E+E KOREA

Tel: +82 31 732 6050
info@epluse.co.kr www.epluse.co.kr

E+E USA

Tel: +1 508 530 3068
office@epluse.com www.epluse.com