



—
your partner
in sensor
technology.

+ Datasheet EE850

CO₂, Humidity and Temperature
Duct Sensor



EE850

CO₂, Humidity and Temperature Duct Sensor

The EE850 combines CO₂, relative humidity (RH) and temperature (T) measurement in an innovative enclosure. It is ideal for demand controlled ventilation and building automation. Due to the CO₂ measuring range up to 10 000 ppm and T working range -20...+60 °C (-4...+140 °F), the EE850 can be employed also in demanding climate and process control.

Long-Term Stability

The EE850 incorporates the E+E dual wavelength NDIR CO₂ sensor, which compensates for ageing effects, is highly insensitive to pollution and offers outstanding long term stability. The RH sensing element is protected against dust, dirt and corrosion by the E+E proprietary coating.

High Measurement Accuracy

A multiple point CO₂ and T factory adjustment procedure leads to excellent CO₂ measurement accuracy over the entire T working range.

Functional Design

Installed into a duct, a small amount of air flows through the divided probe to the CO₂ sensing cell located inside the sensor enclosure and back into the duct. The RH and T sensing elements are placed inside the probe. The functional enclosure facilitates easy and fast mounting of the sensor with closed cover.

Analogue, Digital and Passive T Outputs

The CO₂, RH and T measured data as well as the calculated dew point temperature (Td) are available on various analogue outputs. Additionally, the RS485 interface with Modbus RTU or BACnet MS/TP protocol supplies also other parameters such as absolute humidity (dv), mixing ratio (r), water vapor partial pressure (e) or enthalpy (h).

Easy Configuration and Adjustment

An optional adapter and the free PCS10 product configuration software facilitate the configuration and adjustment of the EE850.



EE850 duct mount

Features

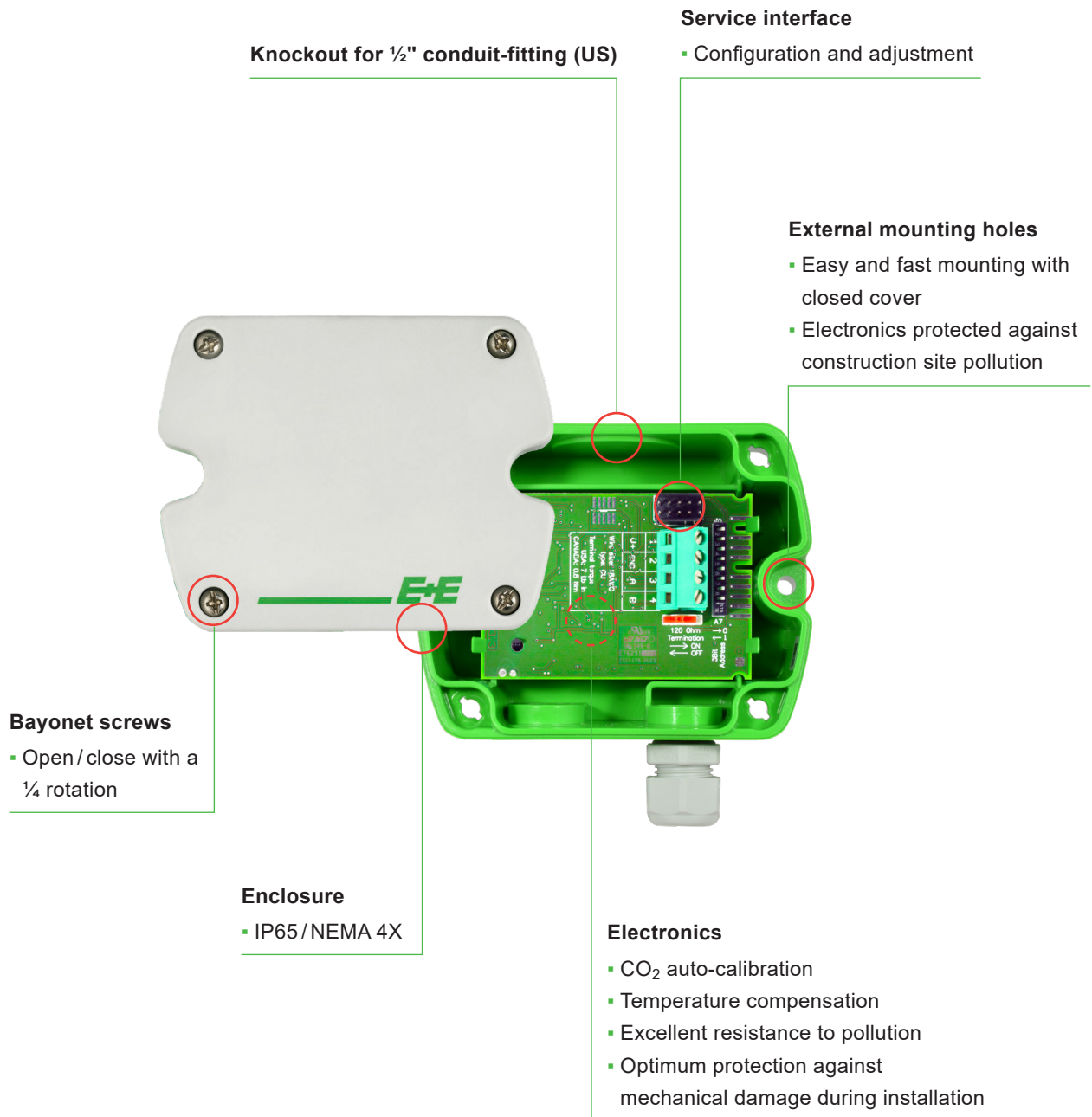

Test report

According to DIN EN 10204-2.2

Features

Protective Sensor Coating

The E+E proprietary sensor coating is a protective layer applied to the sensing elements, their leads and soldering points. The coating substantially extends sensor lifetime and ensures optimal measurement performance in corrosive environment (salts, off-shore applications). Additionally, it improves the sensors' long term stability in dusty, dirty or oily applications by preventing stray impedance caused by deposits on the active sensor surface or on the electrical connections.

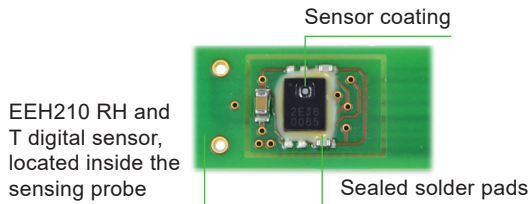

Dimensions

Values in mm (inch)

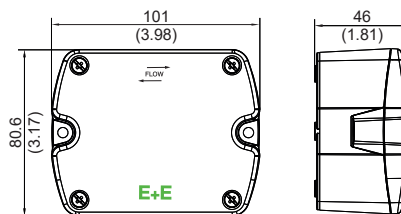
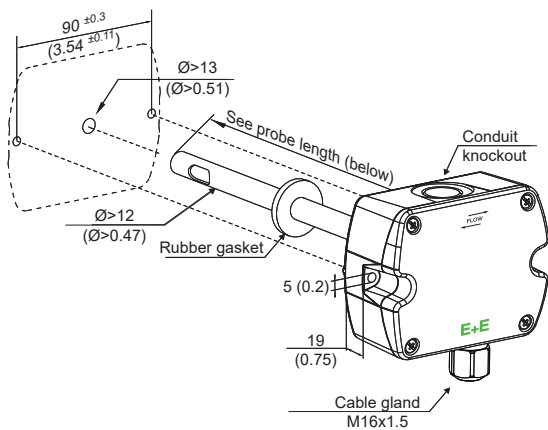

Mounting flange

(Included in the scope of supply)

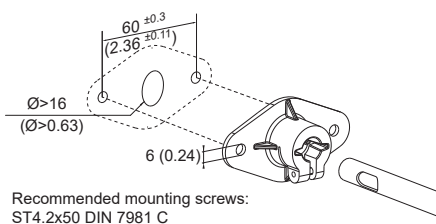

Probe length

L200:

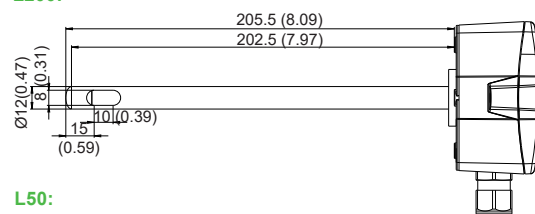

L50:

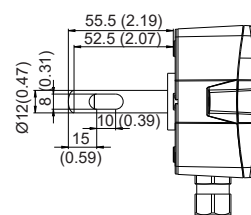

Technical Data

Measurands

CO₂

Measurement principle	Dual wavelength non-dispersive infrared technology (NDIR)
Measuring range	0...2000 / 10000 ppm
Accuracy @ 25 °C (77 °F) and 1013 mbar (14.7 psi) 0...2000 ppm 0...10000 ppm	< ±(50 ppm +2 % of measured value) < ±(100 ppm +5 % of measured value)
Temperature dependency , typ. in the range of -20...+45 °C (-4...+113 °F)	±(1+ CO ₂ concentration [ppm] / 1000) ppm/°C ± 0.556*(1+ CO ₂ concentration [ppm] / 1000) ppm/°F
Response time t ₆₃ , typ.	<100 s at 3 m/s (590 ft/min) air speed in the duct
Measuring interval	Approx. 15 s
Calibration interval Recommended under normal operating conditions in building automation.	>5 years

Temperature (T)

Measuring range	-20...+60 °C (-4...+140 °F)
Accuracy @ 20 °C (68 °F)	±0.3 °C (±0.5 °F)
Response time t ₆₃	<50 s

Relative humidity (RH)

Measuring range	0...95 %RH
Accuracy @ 20 °C (68 °F)	±3 %RH (20...80 %RH)
Response time t ₆₃	<10 s

Outputs

Analogue

RH: 0...100 % T: according to ordering guide	0 - 10 V	-1 mA < I _L < 1 mA	I _L = load current
CO₂ 0...2000/10000 ppm	0 - 10 V 4 - 20 mA	-1 mA < I _L < 1 mA R _L < 500 Ω	R _L = load resistance

T sensor passive

2-wire-connection	T sensor type according ordering guide
Wire resistance (terminal - sensor) , typ.	0.4 Ω

Digital

Digital Interface	RS485 (EE850 = 1/10 unit load)
Protocol Factory settings Supported Baud rates Measured data types	Modbus RTU 9600 Baud, parity even, 1 stop bit, Modbus address 67 9600, 19200 und 38400 FLOAT32 and INT16
Protocol Factory settings Supported Baud rates	BACnet MS/TP BACnet address 67 9600, 19200, 38400, 57 600, 76 800 und 115 200

Ordering Guide

Feature	Description	Code			
Hardware Configuration		EE850-			
	Model	CO ₂	M10		
		CO ₂ + T		M11	
		CO ₂ + T + RH			M12
	CO ₂ measuring range	0...2 000 ppm	HV1		
		0...10 000 ppm	HV3		
	Output	0 - 10 V	A3	A3	A3
		4 - 20 mA	A6		
		RS485	J3	J3	J3
	T sensor passive ¹⁾	Without T sensor		No code	
Pt1000 DIN A			TP3		
Probe length	50 mm (1.97")	L50			
	200 mm (7.87")	No code	No code	No code	
Setup Analogue Outputs ¹⁾	Output 2 measurand	Temperature T [°C]	No code		
		Temperature T [°F]	MB2	MB2	
	Output 2 scaling low	0	No code		
		Value - within the range -20...60 °C	SBLValue	SBLValue	
	Output 2 scaling high	50	No code		
		Value - within the range -20...60 °C	SBHValue	SBHValue	
	Output 3 measurand	Relative humidity RH [%]	No code		
		Dew point Td [°C]	MC52		
		Dew point Td [°F]	MC53		
	Output 3 scaling low	0	No code		
		Value - for Td: within the range -20...60 °C (-4...140 °F)	SCLValue		
	Output 3 scaling high	100	No code		
		Value - for Td: within the range -20...60 °C (-4...140 °F)	SCHValue		
	Setup RS485 ⁴⁾	Protocol	Modbus RTU ²⁾	P1	
BACnet MS/TP ³⁾			P3		
Baud rate		9 600	BD5		
		19 200	BD6		
		38 400	BD7		
		57 600 (only for BACnet)	BD8		
		76 800 (only for BACnet)	BD9		
		115 200 (only for BACnet)	BD10		

- 1) Not with RS485 output (J3) or 50 mm probe length (L50) / T-Sensor details see www.epluse.com/R-T_Characteristics.
- 2) Factory setting: Parity even, 1 stop bit; Modbus Map and communication setting: See User Manual and Modbus Application Note at www.epluse.com/ee850.
- 3) Product Implementation Conformance Statement (PICS) available at www.epluse.com/ee850.
- 4) Not with analogue output A3 und A6.

Order Example

EE850-M12HV1A3MB2SBL32SBH140

Feature	Code	Description
Model	M12	CO ₂ + T + RH
CO ₂ measuring range	HV1	0...2000 ppm
Output	A3	0 - 10 V
Probe length	No code	200 mm (7.87")
Output 2 measurand	MB2	Temperature T [°F]
Output 2 scaling low	SBL32	32 °F
Output 2 scaling high	SBH140	140 °F
Output 3 measurand	No code	Relative humidity RH [%]
Output 3 scaling low	No code	0 %
Output 3 scaling high	No code	100 %

EE850-M10HV1A6L50

Feature	Code	Description
Model	M10	CO ₂
CO ₂ measuring range	HV1	0...2000 ppm
Output	A6	4 - 20 mA
Probe length	L50	50 mm (1.97")

EE850-M12HV3J3P1BD6

Feature	Code	Description
Model	M12	CO ₂ + T + RH
CO ₂ measuring range	HV3	0...10000 ppm
Output	J3	Digital interface RS485
Probe length	No code	200 mm (7.87")
Protocol	P1	Modbus RTU
Baud rate	BD6	19200

Accessories

For further information see datasheet "[Accessories](#)".

Accessories	Code
Configuration adapter cable	HA011066
E+E Product configuration software (Free download: www.epluse.com/pcs10)	PCS10
Power supply adapter	V03



Company Headquarters &
Production Site

E+E Elektronik Ges.m.b.H.
Langwiesen 7
4209 Engerwitzdorf | Austria
T +43 7235 605-0
F +43 7235 605-8
info@epluse.com
www.epluse.com

Subsidiaries

E+E Sensor Technology (Shanghai) Co., Ltd.
T +86 21 6117 6129
info@epluse.cn

E+E Elektronik France SARL
T +33 4 74 72 35 82
info.fr@epluse.com

E+E Elektronik Deutschland GmbH
T +49 6171 69411-0
info.de@epluse.com

E+E Elektronik India Private Limited
T +91 990 440 5400
info.in@epluse.com

E+E Elektronik Italia S.R.L.
T +39 02 2707 86 36
info.it@epluse.com

E+E Korea Co., Ltd.
T +82 31 732 6050
info.kr@epluse.com

E+E Elektronik Corporation
T +1 847 490 0520
info.us@epluse.com



—
your partner
in sensor
technology.