

EE30EX



Humidity/Temperature Transmitter for Intrinsically Safe Applications

EE30EX series transmitters from E+E Elektronik are designed for the accurate measurement of humidity and temperature in the range between 0...100% RH and -40...180°C (-40...356°F). Models for pressure tight installations from 0.01...15 bar (0.15...218psi) complete the range of products.

EE30EX meets the **ATEX requirements** and **IECEX standards** of intrinsically safe machinery:

Applied standards for ATEX:
EN60079-0:2009
EN60079-11:2007
EN60079-26:2007

Applied standards for IECEx:
IEC 60079-0:2011
IEC 60079-11:2011
IEC 60079-26:2006

The EC type examination was carried out by Physikalisch-Technische Bundesanstalt (PTB), the German national institute for science and technology.

The transmitters of EE30EX series consist of:

- EE30EX supply and evaluation unit, classified according to **II (1) G [Ex ia Ga] IIC** subject to EC-type examination certificate **PTB 99 ATEX 2042** and **[Ex ia Ga] IIC** according to **IECEX PTB 05.0031-2**.
- sensor driver unit and sensor probe, classified according to **II 1/2 G Ex ia IIC T6 Ga/Gb** subject to EC-type examination certificate **PTB 99 ATEX 2043 X** and **Ex ia IIC T6 Ga/Gb** according to **IECEX PTB 05.0032X-2**.

The sensor probe can be employed in zone 0 and in temperature class T6 (apparatus group II, category 1). For EE30EX versions D and E the cable length between sensing probe and sensor driver unit can be up to 10m (32.8ft). The maximum length of the cable between the supply and evaluation unit and the sensor driver unit is 100m (328ft).

The analogue output signals for humidity and temperature are available as current or as voltage. State-of-the-art microprocessor technology makes both analogue outputs free selectable and scaleable via RS232 serial interface.

Besides measurement of humidity and temperature EE30EX series calculate the values of the following physical quantities:

- | | |
|---------------------------|----|
| - dew point temperature | Td |
| - frost point temperature | Tf |
| - wet bulb temperature | Tw |
| - water vapour pressure | e |
| - mixing ratio | r |
| - absolute humidity | dv |
| - specific enthalpy | h |

These are available on the RS232 serial interface, on the analogue outputs and on the integrated LC display. The communication with a PC is assisted by an user friendly software, running under MS Windows™ which enables the user to change original factory settings easily.



Model A



Model D



Model E

Configuration Software

The Configuration Software is used for:

- flexible, easy, and fast setup of the analogue outputs resp. of the RS232 serial interface.
- adjustment of the humidity and temperature outputs.
- exchange of the sensor.

Typical Applications

chemical processes
 pharmaceutical applications
 explosive endangered storage rooms

Features

EC-Type examination according to ATEX
 approved to IECEx
 approved for zone 0
 highest accuracy up to 180°C (356°F)
 traceable calibration
 dew point, absolute humidity,... measurement
 incl. MS Windows™ Software

Housing Dimensions (mm)

1m = 3.28ft / 1ft = 0.30m
 1 mm = 0.03937" / 1" = 25.4 mm

wall mounting

EE30EX-A

probe material: stainless steel

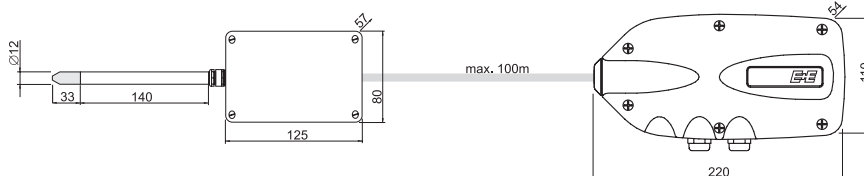

data cable
 pluggable

remote probe up to 180°C (356°F)

EE30EX-D

probe material: stainless steel

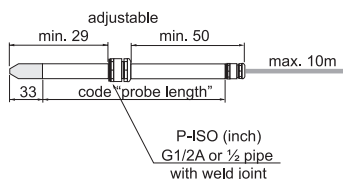
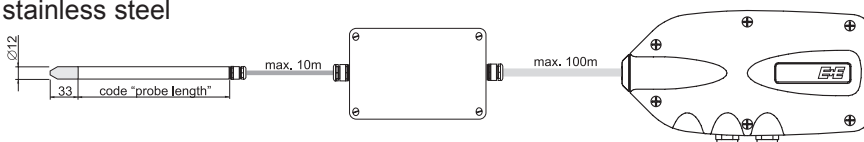

pressure tight probe up to 15 bar (218psi)

EE30EX-E

probe material: stainless steel

Classifications

Europe:

EU (94/9/EG, ATEX 100a)

- supply and evaluation unit:

Ex II (1) G [Ex ia Ga] IIC
 PTB 99 ATEX 2042

- sensor unit:

Ex II 1/2 G Ex ia IIC T6 Ga/Gb
 PTB 99 ATEX 2043 X

- environmental specifications:

T_{amb}: -20...+60°C (-4...140°F)
 P_{amb}: 0.8...1.1bar (11.6...16psi)

International:

- supply and evaluation unit:

Ex [Ex ia Ga] IIC
 IECEx PTB 05.0031-2

- sensor unit:

Ex ia IIC T6 Ga/Gb
 IECEx PTB 05.0032X-2

- environmental specifications:

T_{amb}: -20...+60°C (-4...140°F)
 P_{amb}: 0.8...1.1bar (11.6...16psi)

Technical Data EE30EX

Measuring values

Relative humidity

Humidity sensor ¹⁾	HC1000-400	
Measuring range ¹⁾	0...100% RH	
Accuracy ²⁾ (including hysteresis, non-linearity and repeatability, traceable to international standards, administrated by NIST, PTB, BEV...)		
-15...40°C (5...104°F)	≤90% RH	± (1.3 + 0.3%*mv) % RH
-15...40°C (5...104°F)	>90% RH	± 2.3% RH
-25...70°C (-13...158°F)		± (1.4 + 1%*mv) % RH
-40...180°C (-40...356°F)		± (1.5 + 1.5%*mv) % RH
Temperature dependence electronics	typ. 0.08% RH/°C	
Response time with filter at 20°C / t ₉₀	< 30 sec.	

Temperature

Temperature sensor	Pt1000 (DIN EN 60751, class A)	
Measuring range sensor head	EE30EX-A	-20...60°C (-4...140°F)
	EE30EX-D	-40...180°C (-40...356°F)
	EE30EX-E	-40...180°C (-40...356°F)

Accuracy

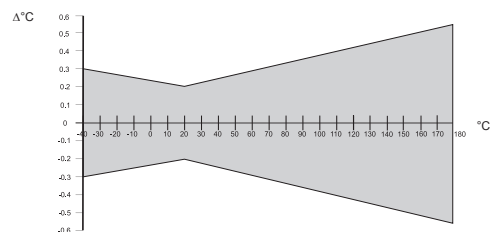

Temperature dependence typical 0.005°C/°C

Max. selectable Scaling Range³⁾

		from	to		unit
			EE30EX-A	EE30EX-D/E	
Humidity	RH	0	100	100	%RH
Temperature	T	-40 (-40)	60 (140)	180 (356)	°C (°F)
Dew point temperature	Td	-40 (-40)	60 (140)	100 (212)	°C (°F)
Frost point temperature	Tf	-40 (-40)	0 (32)	0 (32)	°C (°F)
Wet bulb temperature	Tw	0 (32)	60 (140)	100 (212)	°C (°F)
Water vapour pressure	e	0 (0)	200 (3)	1100 (15)	mbar (psi)
Mixing ratio	r	0 (0)	425 (2900)	999 (9999)	g/kg (gr/lb)
Absolute humidity	dv	0 (0)	150 (60)	700 (300)	g/m ³ (gr/ft ³)
Specific enthalpy	H	-50 (-15000)	400 (150000)	2800 (999999)	kJ/kg (lbf/lb)

Outputs

Two freely selectable and scalable outputs	0 - 5 V	-1 mA < I _L < 1 mA
	0 - 10 V	-1 mA < I _L < 1 mA
	4 - 20 mA	R _L < 360 Ohm
Serial interface	RS232C	

General

Supply voltage	SELV 24V DC/V AC ± 15%	
Current consumption	≤ 150mA (24V DC); ≤ 280mA (24V AC)	
Pressure range with pressure tight sensor probe	0.01...15 bar (0.15...218psi)	
System requirements for software	WINDOWS 2000 or later; serial interface	
Housings	supply- and evaluation unit	ABS-plastic / IP65
	sensor driver unit	AlSi12 / IP65
Cable gland	PG 7 and PG 9; for cable diameter 5 - 9 mm (0.2 - 0.35")	
Electrical connection	screw terminals max. 1.5 mm ² (AWG 16)	
Sensor protection	sintered stainless steel filter, PTFE-filter or metal grid filter	
Temperature range	sensor probe:	according measuring range
	electronic sensor driver device:	-20...60°C (-4...140°F)
	electronic supply- and evaluation device:	-40...60°C (-40...140°F)
	electronic with display:	0...40°C (32...104°F)
Storage temperature range	electronics and sensor head	-30...60°C (22...140°F)
Electromagnetic compatibility according	EN61326-1	EN61326-2-3
	Industrial Environment	ICES-003 ClassB
		FCC Part15 ClassB

1) Refer to the working range of the humidity sensor.

3) Refer to accuracies of calculated values.

2) The accuracy statement includes the uncertainty of the factory calibration with an enhancement factor k=2 (2-times standard deviation). The accuracy was calculated in accordance with EA-4/02 and with regard to GUM (Guide to the Expression of Uncertainty in Measurement).

Working Range Humidity Sensor

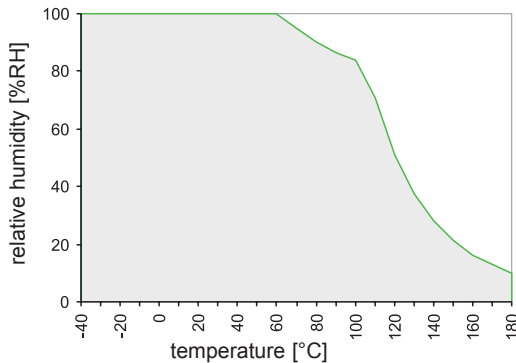

The specified working range for the humidity sensor element is shown in terms of humidity/temperature limits.

Although the sensors would not deteriorate beyond the limits, their performance can only be specified within the limits for the working range.

Sensing head with protective coating

For use in heavy polluted or aggressive environment E+E has developed a special protective coating process (order code: HC01). Both humidity and temperature sensor elements are covered with a polymer film. Extensive tests have proved an amazing improvement of the resistance to chemical pollutants which leads to a much better long term stability of the transmitter.

Connection Diagram

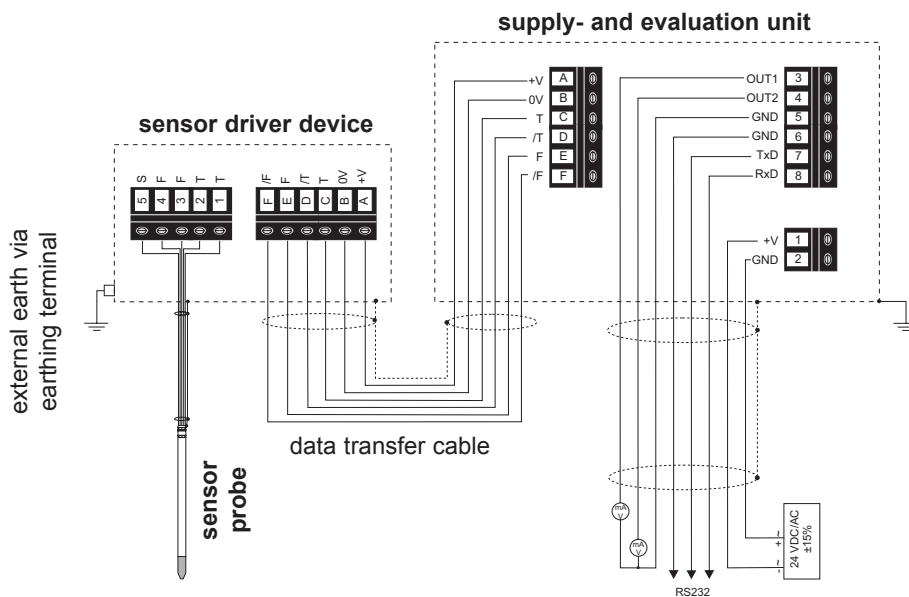

Installation

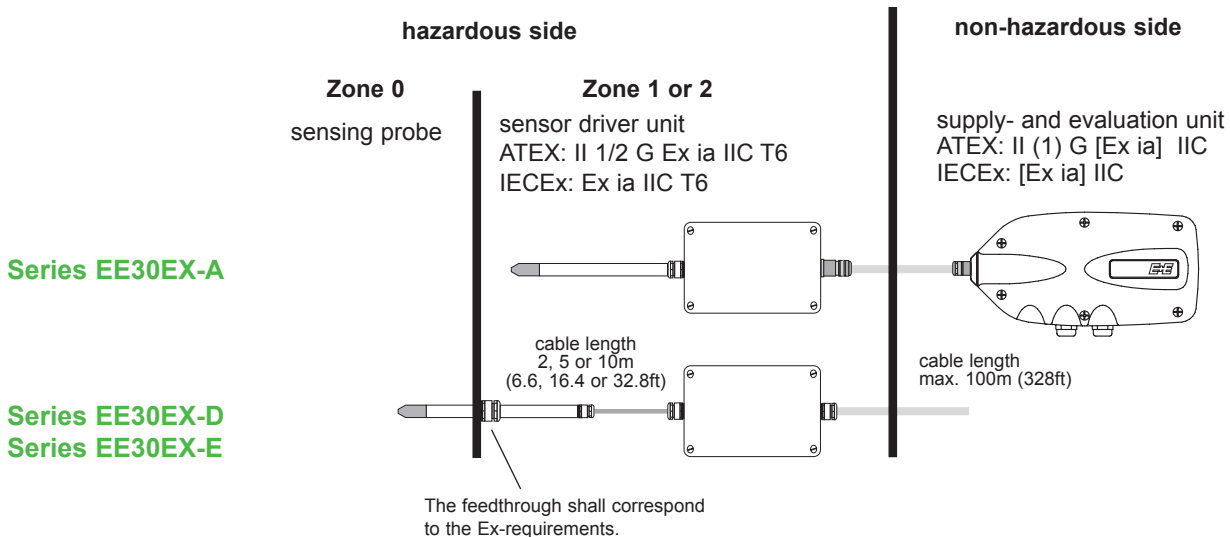

Ordering Guide EE30EX

Position 1 - Transmitter

		EE30EX-A	EE30EX-D	EE30EX-E			
Hardware Configuration							
Filter	stainless steel sintered filter	3	3	3			
	PTFE filter ¹⁾	5	5	5			
	metal grid filter (up to 120°C/248 °F)*	6	6	6			
	stainless steel grid filter (up to 180°C/ 356 °F)	9	9	9			
Cable length	2m (6.6ft)		02	02			
	5m (16.4ft)		05	05			
	10m (32.8ft)		10	10			
Probe length	200mm (7.9")		5	5			
	400mm (15.8")		6	6			
Pressure tight	1/2" male thread		HA03	HA03			
Feedthrough	1/2" pipe weld joint		HA05	HA05			
	1/2" NPT thread		HA07	HA07			
Data cable	not pluggable						
	pluggable	P02	P02	P02			
Display	without display						
	with display	D01	D01	D01			
Coating sensor	no						
	yes	HC01	HC01	HC01			
Software Configuration							
Physical parameters of outputs	Relative humidity	RH [%]	(A)	Output 1	Select according to Ordering Guide(A-H, J)		
	Temperature	T [°C]	(B)	Output 2			
	Dew point temperature	Td [°C]	(C)				
	Frost point temperature	Tf [°C]	(D)				
	Wet bulb temperature	Tw [°C]	(E)				
	Water vapour partial pres.	e [mbar]	(F)				
	Mixture ratio	r [g/kg]	(G)				
	Absolute humidity	dv [g/m ³]	(H)				
	Specific enthalpy	h [kJ/kg]	(J)				
	Type of output signals	0-5V		(2)		Select according to Ordering Guide(2,3,6)	
0-10V			(3)				
4-20mA			(6)				
Measure value units	metric / SI			E01	E01	E01	
	non metric / US						
Scaling of T-output	-40...60 (T02)	-40...120 (T12)	-40...160 (T33)	Output T	Select according to Ordering Guide (Txx)		
	-10...50 (T03)	-20...100 (T14)	-40...180 (T52)				
Scaling of Td-output in °C or °F	0...50 (T04)	+20...120 (T15)	-40...140 (T83)	Output Td	Select according to Ordering Guide (Tdx)		
	0...100 (T05)	0...120 (T16)	32...120 (T90)				
	0...60 (T07)	0...80 (T21)	32...140 (T91)				
	-30...70 (T08)	-40...80 (T22)	32...180 (T92)				
	-30...120 (T09)	-20...80 (T24)	32...132 (T96)				
	-20...120 (T10)	-20...60 (T25)					
Position 2 - Data cable							
Data cable	maximal 100m (328ft) / transmitter	xxxm	xxxm	xxxm			

¹⁾ to be used for the apparatus group II B only

Order Example

Position 1 - Transmitter: **EE30EX-E3056HA03P02/BC3-T05-Td14**
 Humidity/Temperature Transmitter Series EE30EX

Model: For pressure tight installations
 Filter: stainless steel sintered filter
 Cable length: 5m (16.4ft)
 Probe length: 400mm (15.8")
 Feedthrough: 1/2" male thread
 Data cable: pluggable
 Output 1: T
 Output 2: Td
 Output signal: 0-10V
 Scaling of T-output: 0...100°C
 Scaling of Td-output: -20...100°C

Position 2 - Data cable: **Data cable 60m (196.8ft)**

YOUR PARTNER IN SENSOR TECHNOLOGY

